

# Dell G15 5530

## Owner's Manual



## Notes, cautions, and warnings

 **NOTE:** A NOTE indicates important information that helps you make better use of your product.

 **CAUTION:** A CAUTION indicates either potential damage to hardware or loss of data and tells you how to avoid the problem.

 **WARNING:** A WARNING indicates a potential for property damage, personal injury, or death.

<b>Chapter 1: Views of Dell G15 5530.....</b>	<b>7</b>
Right.....	7
Left.....	7
Top.....	8
Front.....	9
Bottom.....	10
Back.....	10
Service Tag.....	11
<b>Chapter 2: Set up your Dell G15 5530.....</b>	<b>12</b>
<b>Chapter 3: Specifications of Dell G15 5530.....</b>	<b>14</b>
Dimensions and weight.....	14
Processor.....	14
Chipset.....	15
Operating system.....	16
Memory.....	16
External ports.....	16
Internal slots.....	17
Ethernet.....	17
Wireless module.....	17
Audio.....	18
Storage.....	18
Keyboard.....	18
Keyboard shortcuts.....	19
Camera.....	20
Touchpad.....	21
Power adapter.....	21
Battery.....	22
Display.....	23
GPU—Integrated.....	24
GPU—Discrete.....	24
Operating and storage environment.....	24
ComfortView Plus.....	25
<b>Chapter 4: Working inside your computer.....</b>	<b>26</b>
Safety instructions.....	26
Before working inside your computer.....	26
Safety precautions.....	27
Electrostatic discharge—ESD protection.....	27
ESD field service kit .....	28
Transporting sensitive components.....	29
After working inside your computer.....	29
BitLocker.....	29

Recommended tools.....	29
Screw list.....	29
Major components of Dell G15 5530.....	31
<b>Chapter 5: Removing and installing Customer Replaceable Units (CRUs).....</b>	<b>34</b>
Base cover.....	34
Removing the base cover.....	34
Installing the base cover.....	37
Solid-state drive.....	39
Removing the solid-state drive .....	39
Installing the solid-state drive.....	40
Wireless card.....	42
Removing the wireless card.....	42
Installing the wireless card.....	43
Memory.....	44
Removing the memory module.....	44
Installing the memory module.....	44
Speakers.....	45
Removing the speakers.....	45
Installing the speakers.....	46
Rear cover.....	47
Removing the rear cover.....	47
Installing the rear cover.....	48
<b>Chapter 6: Removing and installing Field Replaceable Units (FRUs).....</b>	<b>50</b>
Battery.....	50
Rechargeable Li-ion battery precautions.....	50
Removing the battery.....	50
Installing the battery.....	52
Touchpad.....	53
Removing the touchpad.....	53
Installing the touchpad.....	54
Display assembly.....	55
Removing the display assembly.....	55
Installing the display assembly.....	58
Keyboard-controller board.....	61
Removing the keyboard-controller board.....	61
Installing the keyboard-controller board.....	61
Power-adapter port.....	62
Removing the power-adapter port.....	62
Installing the power-adapter port.....	63
System board.....	64
Removing the system board (Single-color keyboard).....	64
Installing the system board (Single-color keyboard).....	67
Removing the system board (Four-zone keyboard).....	70
Installing the system board (Four-zone keyboard).....	73
USB board.....	76
Removing the USB board.....	76
Installing the USB board.....	77

Ethernet and audio board.....	78
Removing the ethernet and audio board.....	78
Installing the ethernet and audio board.....	79
Fan and heat-sink assembly.....	80
Removing the fan and heat-sink assembly .....	80
Installing the fan and heat-sink assembly .....	81
Power-button assembly.....	82
Removing the power button.....	82
Installing the power button.....	83
Palm-rest and keyboard assembly.....	84
Removing the palm-rest and keyboard assembly.....	84
Installing the palm-rest and keyboard assembly.....	85
<b>Chapter 7: Software.....</b>	<b>87</b>
Operating system.....	87
Drivers and downloads.....	87
<b>Chapter 8: Technology and components.....</b>	<b>88</b>
<b>Chapter 9: BIOS setup.....</b>	<b>89</b>
Entering BIOS setup program.....	89
Navigation keys.....	89
One Time Boot menu.....	89
System setup options.....	90
Updating the BIOS.....	99
Updating the BIOS in Windows.....	99
Updating the BIOS using the USB drive in Windows.....	99
Updating the BIOS in Linux and Ubuntu.....	100
Updating the BIOS from the F12 One Time Boot menu.....	100
System and setup password.....	101
Assigning a system setup password.....	101
Deleting or changing an existing system setup password.....	101
Clearing CMOS settings.....	102
Clearing BIOS (System Setup) and System passwords.....	102
<b>Chapter 10: Troubleshooting.....</b>	<b>103</b>
Handling swollen rechargeable Li-ion batteries.....	103
<b>Locate the Service Tag or Express Service Code of your Dell computer .....</b>	<b>103</b>
Dell SupportAssist Pre-boot System Performance Check diagnostics.....	104
Running the SupportAssist Pre-Boot System Performance Check.....	104
Built-in self-test (BIST).....	104
M-BIST.....	104
LCD Power rail test (L-BIST).....	105
LCD Built-in Self Test (BIST).....	105
System-diagnostic lights.....	106
Recovering the operating system.....	107
Real-Time Clock (RTC Reset).....	107
Backup media and recovery options.....	107
Wi-Fi power cycle.....	107

Drain residual flea power (perform hard reset).....108

**Chapter 11: Getting help and contacting Dell..... 109**

# Views of Dell G15 5530

## Right

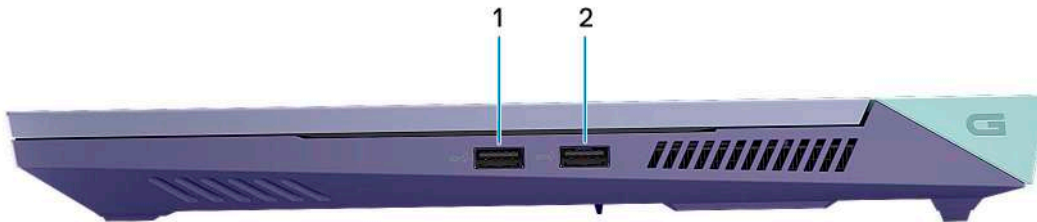

### 1. USB 3.2 Gen 1 ports (2)

Connect devices such as external storage devices and printers. Provides data transfer speeds up to 5 Gbps.

## Left

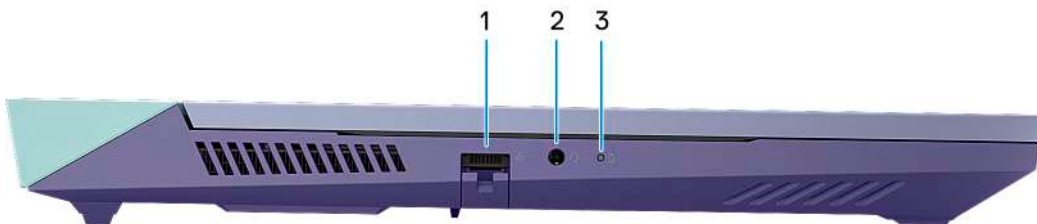

### 1. Network port

Connect an Ethernet (RJ45) cable from a router or a broadband modem for network or Internet access.

### 2. Universal audio jack

Connect audio-output devices such as speakers, amplifiers, and so on.

### 3. Battery-status light

Indicates the battery-charge status.

Solid amber—Battery charge is low.

Blinking amber—Battery charge is critical.

Off—Battery is fully charged.

# Top

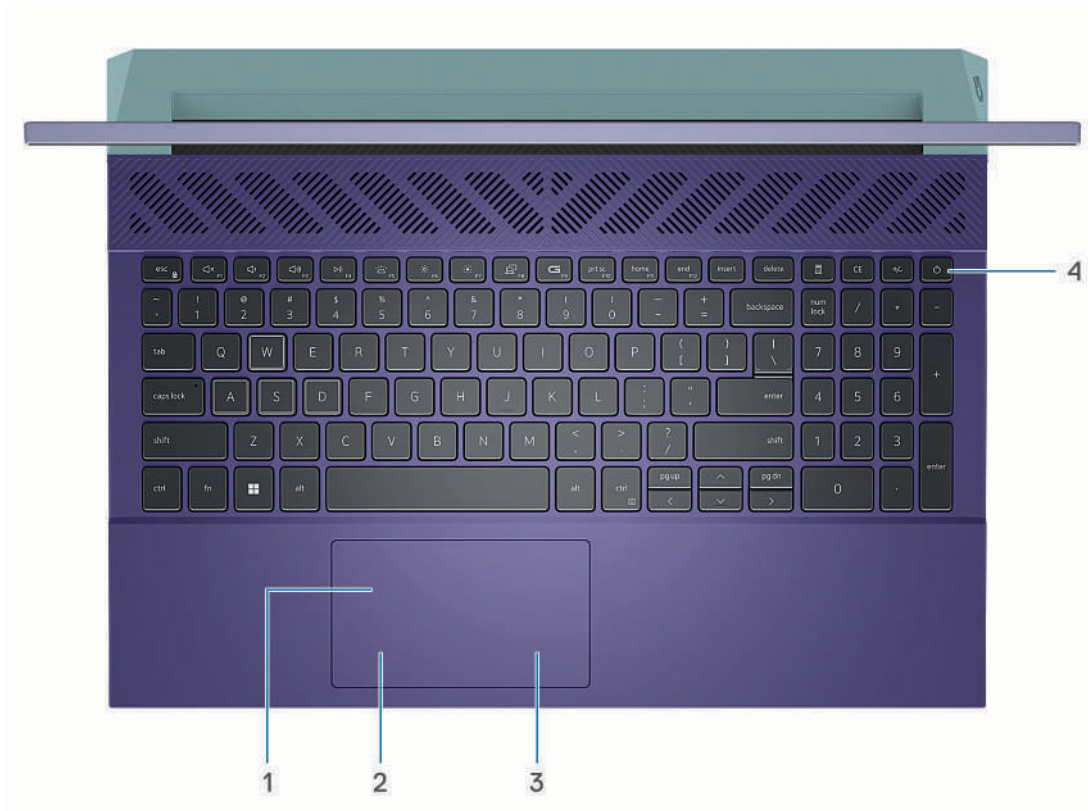

## 1. Touchpad

Move your finger on the touchpad to move the mouse pointer. Tap to left-click and two fingers tap to right-click.

## 2. Left-click area

Press to left-click.

## 3. Right-click area

Press to right-click.

## 4. Power button

Press to turn on the computer if it is turned off, in sleep state, or in hibernate state.

When the computer is turned on, press the power button to put the computer into sleep state; press and hold the power button for 10 seconds to force shut-down the computer.

**NOTE:** You can customize the power-button behavior in Windows. For more information, see *Me and My Dell* at [www.dell.com/support/manuals](http://www.dell.com/support/manuals).



# Front



- 1. Camera**  
Enables you to video chat, capture photos, and record videos.
- 2. Camera-status light**  
Turns on when the camera is in use.
- 3. Microphone**  
Provides digital sound input for audio recording, voice calls, and so on.

## Bottom

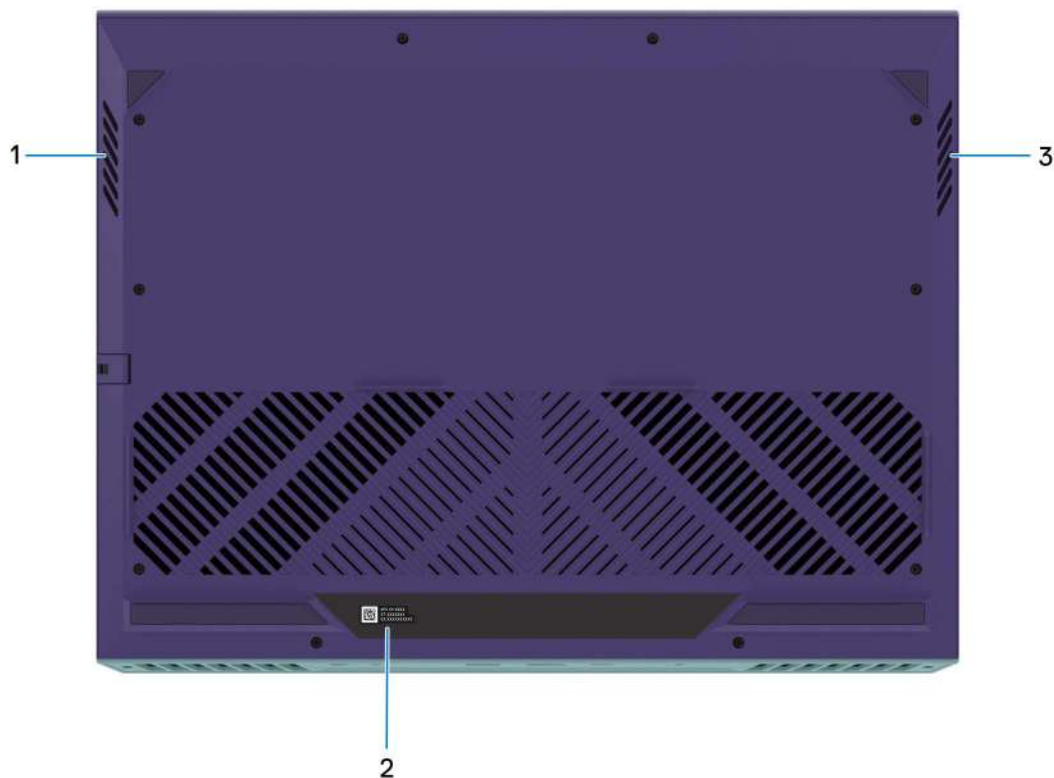

### 1. Left speaker

Provides audio output.

### 2. Service Tag label

The Service Tag is a unique alphanumeric identifier that enables Dell service technicians to identify the hardware components in your computer and access warranty information.

### 3. Right speaker

Provides audio output.

## Back

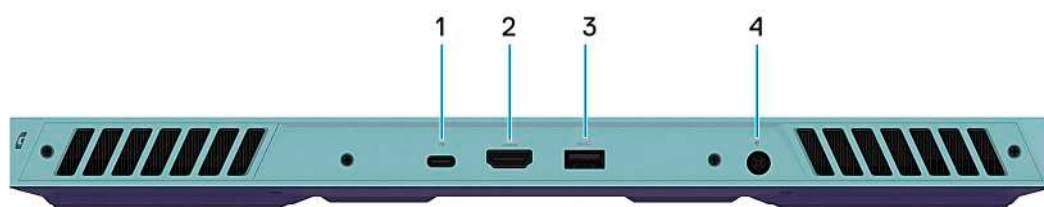

### 1. USB 3.2 Gen 2 (Type-C) port with DisplayPort

Connect devices such as external storage devices, printers, and external displays. Provides data transfer rate of up to 10 Gbps.

Supports DisplayPort 1.4 and also enables you to connect an external display using a display adapter.

**NOTE:** This port is only available on computers shipped with an NVIDIA GeForce RTX 3050/4050/4060 graphics card.

**NOTE:** A USB Type-C to DisplayPort adapter (sold separately) is required to connect a DisplayPort device.

**2. HDMI port**

Connect to a TV, external display or another HDMI-in enabled device. Provides video and audio output.

**3. USB 3.2 Gen 1 port**

Connect devices such as external storage devices and printers. Provides data transfer speeds up to 5 Gbps.

**4. Power-adapter port**

Connect a power adapter to provide power to your computer and charge the battery.

## Service Tag

The service tag is a unique alphanumeric identifier that allows Dell service technicians to identify the hardware components in your computer and access warranty information.

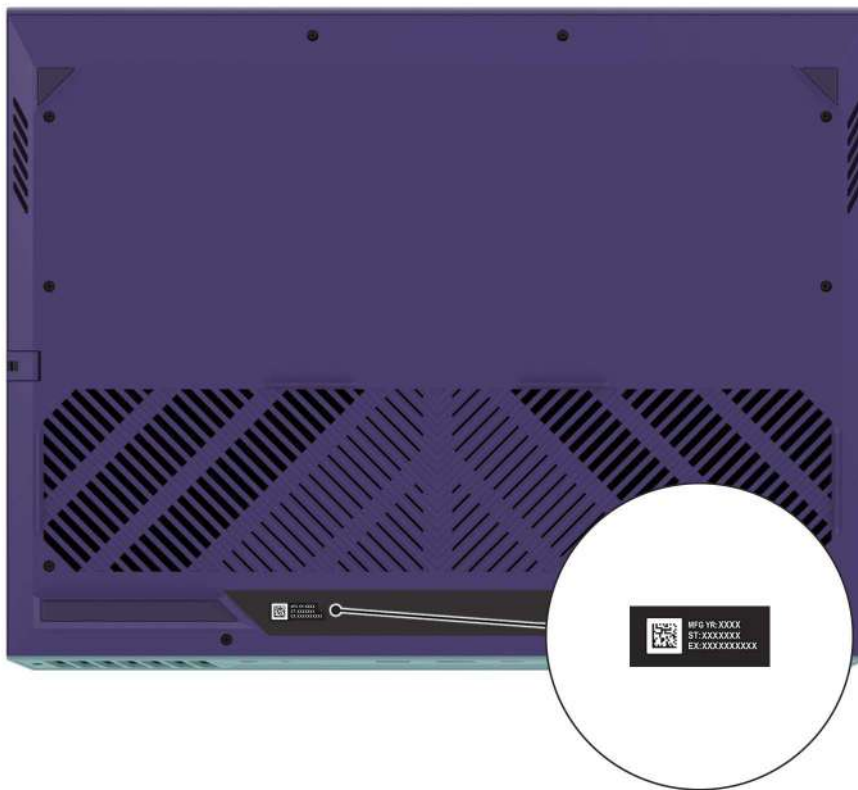

# Set up your Dell G15 5530

## About this task

**NOTE:** The images in this document may differ from your computer depending on the configuration you ordered.

## Steps

1. Connect the power adapter and press the power button.



**NOTE:** The battery may go into power-saving mode during shipment to conserve charge on the battery. Ensure that the power adapter is connected to your computer when it is turned on for the first time.

2. Finish Windows setup.

Follow the on-screen instructions to complete the setup. When setting up, Dell recommends that you:





- Connect to a network for Windows updates.

**NOTE:** If connecting to a secured wireless network, enter the password for the wireless network access when prompted.

- If connected to the Internet, sign in with or create a Microsoft account. If not connected to the Internet, create an offline account.
- On the **Support and Protection** screen, enter your contact details.

3. Locate and use Dell apps from the Windows Start menu—Recommended.

**Table 1. Locate Dell apps**

Resources	Description
	<p><b>My Dell</b></p> <p>Centralized location for key Dell applications, help articles, and other important information about your computer. It also notifies you about the warranty status, recommended accessories, and software updates if available.</p>
	<p><b>SupportAssist</b></p> <p>SupportAssist proactively and predictively identifies hardware and software issues on your computer and automates the engagement process with Dell Technical support. It addresses performance and stabilization issues, prevents security threats, monitors, and detects hardware failures. For more information, see <i>SupportAssist for Home PCs User's Guide</i> at <a href="http://www.dell.com/serviceabilitytools">www.dell.com/serviceabilitytools</a>. Click <b>SupportAssist</b> and then, click <b>SupportAssist for Home PCs</b>.</p> <p><b>NOTE:</b> In SupportAssist, click the warranty expiry date to renew or upgrade your warranty.</p>
	<p><b>Dell Update</b></p> <p>Updates your computer with critical fixes and latest device drivers as they become available. For more information on using Dell Update, search in the Knowledge Base Resource at <a href="http://www.dell.com/support">www.dell.com/support</a>.</p>
	<p><b>Dell Digital Delivery</b></p> <p>Download software applications, which are purchased but not preinstalled on your computer. For more information on using Dell Digital Delivery, search in the Knowledge Base Resource at <a href="http://www.dell.com/support">www.dell.com/support</a>.</p>

# Specifications of Dell G15 5530

## Dimensions and weight

The following table lists the height, width, depth, and weight of your Dell G15 5530.



**Table 2. Dimensions and weight**

Description	Values
Height:	
Front height	21.28 mm (0.83 in.)
Rear height	26.15 mm (1.02 in.)
Width	357.26 mm (14.06 in.)
Depth	274.52 mm (10.80 in.)
Weight  <b>NOTE:</b> The weight of your computer depends on the configuration ordered and manufacturing variability.	2.81 kg (6.20 lb)

## Processor

The following table lists the details of the processors supported by your Dell G15 5530.

**Table 3. Processor**

Description	Option one	Option two	Option three	Option four
Processor type	13 <sup>th</sup> Generation Intel Core i5-13450HX	13 <sup>th</sup> Generation Intel Core i7-13650HX	13 <sup>th</sup> Generation Intel Core i7-13700HX	13 <sup>th</sup> Generation Intel Core i9-13900HX
Processor wattage	55 W	55 W	55 W	55 W
Processor total core count	10	14	16	24
Performance-cores	6	6	8	8
Efficient-cores	4	8	8	16
Processor total thread counts	16	20	24	32
 <b>NOTE:</b> Intel® Hyper-Threading Technology is only available on Performance-cores.				
Performance-cores frequency				
Processor base frequency	2.40 GHz	2.60 GHz	2.10 GHz	2.20 GHz
Maximum turbo frequency	Up to 4.60 GHz	Up to 4.90 GHz	Up to 5 GHz	Up to 5.40 GHz
Efficient-cores frequency				
Processor base frequency	1.80 GHz	1.90 GHz	1.50 GHz	1.60 GHz
Maximum turbo frequency	3.40 GHz	3.60 GHz	3.70 GHz	3.90 GHz
 <b>NOTE:</b> Processor clock speeds and thermal design power differ according to the thermal mode selected in the My Dell app on your computer.				
Processor cache	20 MB	24 MB	30 MB	36 MB
Integrated graphics	Intel UHD Graphics	Intel UHD Graphics	Intel UHD Graphics	Intel UHD Graphics

## Chipset

The following table lists the details of the chipset supported by your Dell G15 5530.

**Table 4. Chipset**

Description	Values
Chipset	HM770
Processor	13 <sup>th</sup> Generation Intel Core i5/i7/i9
DRAM bus width	64-bit
Flash EPROM	32 MB
PCIe bus	Up to Gen4

# Operating system

Your Dell G15 5530 supports the following operating systems:

- Windows 11 Professional, 64-bit
- Windows 11 Home, 64-bit
- Ubuntu 20.04 LTS, 64-bit

# Memory

The following table lists the memory specifications of your Dell G15 5530.

**Table 5. Memory specifications**

Description	Values
Memory slots	Two-SODIMM slots
Memory type	DDR5
Memory speed	4800
Maximum memory configuration	32 GB
Minimum memory configuration	8 GB
Memory size per slot	8 GB or 16 GB
Memory configurations supported	<ul style="list-style-type: none"><li>• 8 GB, 1 x 8 GB, DDR5, 4800 MHz</li><li>• 16 GB, 1 x 16 GB, DDR5, 4800 MHz</li><li>• 16 GB, 2 x 8 GB, DDR5, 4800 MHz, dual-channel</li><li>• 32 GB, 2 x 16 GB, DDR5, 4800 MHz, dual-channel</li></ul>

# External ports

The following table lists the external ports of your Dell G15 5530.

**Table 6. External ports**

Description	Values
Network port	One RJ-45 port
USB ports	<ul style="list-style-type: none"><li>• Three USB 3.2 Gen 1 ports</li><li>• One USB 3.2 Gen 2 (Type-C) with DisplayPort</li></ul>
Audio port	One universal audio jack
Video port	One HDMI 2.1 port
Media-card reader	Not applicable
Power-adaptor port	One 7.4 mm x 5.1 mm power-adaptor port
Security-cable slot	Not supported



# Internal slots

The following table lists the internal slots of your Dell G15 5530.

**Table 7. Internal slots**

Description	Values
M.2	<ul style="list-style-type: none"><li>One M.2 2230 slot for WiFi and Bluetooth combo card</li><li>Two M.2 2230/2280 slots for solid-state drives</li></ul> <p><b>NOTE:</b> To learn more about the features of different types of M.2 cards, search in the Knowledge Base Resource at <a href="http://www.dell.com/support">www.dell.com/support</a>.</p>

# Ethernet

The following table lists the wired Ethernet Local Area Network (LAN) specifications of your Dell G15 5530.

**Table 8. Ethernet specifications**

Description	Values
Model number	Realtek RTL8111H PCI-e 1 Gigabit ethernet controller
Transfer rate	10/100/1000 Mbps

# Wireless module

The following table lists the Wireless Local Area Network (WLAN) module that is supported on your Dell G15 5530.

**Table 9. Wireless module specifications**

Description	Values
Model number	Intel AX201
Transfer rate	2400 Mbps
Frequency bands supported	2.4 GHz/5 GHz
Wireless standards	<ul style="list-style-type: none"><li>WiFi 802.11a/b/g</li><li>Wi-Fi 4 (WiFi 802.11n)</li><li>Wi-Fi 5 (WiFi 802.11ac)</li><li>Wi-Fi 6 (WiFi 802.11ax)</li></ul>
Encryption	<ul style="list-style-type: none"><li>64-bit/128-bit WEP</li><li>AES-CCMP</li><li>TKIP</li></ul>
Bluetooth wireless card	Bluetooth 5.2
	<p><b>NOTE:</b> The version of the Bluetooth wireless card may vary depending on the operating system that is installed on your computer.</p>

# Audio

The following table lists the audio specifications of your Dell G15 5530.

**Table 10. Audio specifications**

Description	Values
Audio controller	Realtek ALC3204
Stereo conversion	Supported
Internal audio interface	High definition audio
External audio interface	One universal audio jack
Number of speakers	Two
Internal-speaker amplifier	Supported
External volume controls	Keyboard shortcut controls
Speaker output:	
Average speaker output	2 x 2 W = 4 W
Peak speaker output	2 x 2.5 W = 5 W
Subwoofer output	Not supported
Microphone	One microphone in camera assembly

# Storage

This section lists the storage options on your Dell G15 5530.

Your Dell G15 5530 supports one of the following storage configurations:

- One M.2 2230 or M.2 2280 solid-state drive
- Two M.2 2230 or M.2 2280 solid-state drives

The primary drive of your Dell G15 5530 is installed in solid-state drive slot one.

**Table 11. Storage specifications**

Storage type	Interface type	Capacity
M.2 2230 solid-state drive	PCIe NVMe Gen4 x4	Up to 1 TB
M.2 2280 solid-state drive	PCIe NVMe Gen4 x4	Up to 2 TB

# Keyboard

The following table lists the keyboard specifications of your Dell G15 5530.

**Table 12. Keyboard specifications**

Description	Values
Keyboard type	<ul style="list-style-type: none"><li>• Single-color backlit (white) keyboard</li><li>• Single-color backlit (hot coral) keyboard</li></ul>

**Table 12. Keyboard specifications (continued)**

Description	Values
	<ul style="list-style-type: none"> <li>Four-zone RGB backlit keyboard</li> </ul>
Keyboard layout	QWERTY
Number of keys	<ul style="list-style-type: none"> <li>United States and Canada: 101 keys</li> <li>United Kingdom: 102 keys</li> <li>Japan: 105 keys</li> </ul>
Keyboard size	X=18.70 mm key pitch Y=18.05 mm key pitch
Keyboard shortcuts	Some keys on your keyboard have two symbols on them. These keys can be used to type alternate characters or to perform secondary functions. To type the alternate character, press Shift and the desired key. To perform secondary functions, press Fn and the desired key. ⓘ <b>NOTE:</b> You can define the primary behavior of the function keys (F1–F12) changing <b>Function Key Behavior</b> in BIOS setup program.

## Keyboard shortcuts

ⓘ **NOTE:** Keyboard characters may differ depending on the keyboard language configuration. Keys that are used for shortcuts remain the same across all language configurations.





Some keys on your keyboard have two symbols on them. These keys can be used to type alternate characters or to perform secondary functions. The symbol shown on the lower part of the key refers to the character that is typed out when the key is pressed. If you press shift and the key, the symbol shown on the upper part of the key is typed out. For example, if you press **2**, **2** is typed out; if you press **Shift + 2**, **@** is typed out.

The keys F1-F12 at the top row of the keyboard are function keys for multi-media control, as indicated by the icon at the bottom of the key. Press the function key to invoke the task represented by the icon. For example, pressing F1 mutes the audio (refer to the table below).



However, if the function keys F1-F12 are needed for specific software applications, multi-media functionality can be disabled by pressing **fn + Esc**. Subsequently, multi-media control can be invoked by pressing **fn** and the respective function key. For example, mute audio by pressing **fn + F1**.

ⓘ **NOTE:** You can also define the primary behavior of the function keys (F1–F12) by changing **Function Key Behavior** in BIOS setup program.

**Table 13. List of keyboard shortcuts**





Keys	Description
	Launch Windows Connect to display connected Bluetooth devices
	Adjust keyboard backlight brightness
	Switch to external display
	Disable/enable Game Shift
	Decrease display brightness

**Table 13. List of keyboard shortcuts (continued)**

Keys	Description
	Increase display brightness
	Disable/enable touchpad





Your computer comes with pre-programmable macro keys that enable you to perform multiple actions with a single key press.

**Table 14. List of Macro keys**

Keys	Description
	Macro keys ⓘ <b>NOTE:</b> You can configure modes and assign multiple tasks for the macro keys on the keyboard.
	
	
	
	

Your computer comes with dedicated keys that enable you to control audio features of the computer with a single key press.

**Table 15. List of keys to control audio features**

Keys	Description
	Mute microphone
	Mute speakers
	Increase volume
	Decrease volume

## Camera

The following table lists the camera specifications of your Dell G15 5530.

**Table 16. Camera specifications**

Description	Values
Number of cameras	One
Camera type	HD RGB camera
Camera location	Front camera
Camera sensor type	CMOS sensor technology
Camera resolution:	
Still image	0.92 megapixel

**Table 16. Camera specifications (continued)**

Description		Values
	Video	1280 x 720 (HD) at 30 fps
Diagonal viewing angle:		78.6 degrees

## Touchpad

The following table lists the touchpad specifications of your Dell G15 5530.

**Table 17. Touchpad specifications**

Description		Values
Touchpad resolution:		
	Horizontal	1229
	Vertical	689
Touchpad dimensions:		
	Horizontal	105 mm (4.13 in.)
	Vertical	60 mm (2.36 in.)
Touchpad gestures		For more information about touchpad gestures available on: <ul style="list-style-type: none"> <li>Windows, see the Microsoft knowledge base article at <a href="https://support.microsoft.com">support.microsoft.com</a></li> <li>Ubuntu, see <a href="https://ubuntu.com/support">ubuntu.com/support</a></li> </ul>

## Power adapter

The following table lists the power adapter specifications of your Dell G15 5530.

**Table 18. Power adapter specifications**

Description	Option one	Option two
Type	240 W	330 W
Connector dimensions:		
External diameter	7.40 mm (0.29 in.)	7.40 mm (0.29 in.)
Internal diameter	5.10 mm (0.20 in.)	5.10 mm (0.20 in.)
Power-adapter dimensions:		
Height	25.40 mm (1 in.)	43 mm (1.69 in.)
Width	100 mm (3.94 in.)	100 mm (3.94 in.)
Depth	200 mm (7.87 in.)	200 mm (7.87 in.)
Input voltage	100 VAC x 240 VAC	100 VAC x 240 VAC
Input frequency	50 Hz x 60 Hz	50 Hz x 60 Hz

**Table 18. Power adapter specifications (continued)**

Description		Option one	Option two
Input current (maximum)		3.50 A	4.40 A
Output current (continuous)		12.31 A	16.92 A
Rated output voltage		19.50 VDC	19.50 VDC
Temperature range:			
	Operating	0°C to 40°C (32°F to 104°F)	0°C to 40°C (32°F to 104°F)
	Storage	-40°C to 70°C (-40°F to 158°F)	-40°C to 70°C (-40°F to 158°F)
 <b>CAUTION: Operating and storage temperature ranges may differ among components, so operating or storing the device outside these ranges may impact the performance of specific components.</b>			

## Battery

The following table lists the battery specifications of your Dell G15 5530.

**Table 19. Battery specifications**

Description		Option one	Option two
Battery type		6-cell, 56 WHr, Lithium-ion, ExpressCharge Boost	6-cell, 86 WHr, Lithium-ion, ExpressCharge Boost
Battery voltage		11.40 VDC	11.40 VDC
Battery weight (maximum)		0.25 Kg (0.56 lb)	0.34 kg (0.75 lb)
Battery dimensions:			
	Height	7.56 mm (0.30 in.)	7.56 mm (0.30 in.)
	Width	77.70 mm (3.06 in.)	77.70 mm (3.06 in.)
	Depth	295.20 mm (11.62 in.)	295.20 mm (11.62 in.)
Temperature range:			
	Operating	<ul style="list-style-type: none"> <li>Charge: 0°C to 50°C (32°F to 122°F)</li> <li>Discharge: 0°C to 60°C (32°F to 140°F)</li> </ul>	<ul style="list-style-type: none"> <li>Charge: 0°C to 50°C (32°F to 122°F)</li> <li>Discharge: 0°C to 60°C (32°F to 140°F)</li> </ul>
	Storage	-20°C to 65°C (-4°F to 149°F)	-20°C to 65°C (-4°F to 149°F)
Battery operating time		Varies depending on operating conditions and can significantly reduce under certain power-intensive conditions.	Varies depending on operating conditions and can significantly reduce under certain power-intensive conditions.
Battery charging time (approximate)  <b>NOTE:</b> Control the charging time, duration, start and end time, and so on using the Dell Power Manager application. For more information about Dell Power Manager, search		<ul style="list-style-type: none"> <li>Express Charge Method: 2 hours</li> <li>Standard Charge/Predominately AC User Charge Method: 3 hours</li> <li>Express Charge Boost Charge Method (Fast Charge for Initial</li> </ul>	<ul style="list-style-type: none"> <li>Express Charge Method: 2 hours</li> <li>Standard Charge/Predominately AC User Charge Method: 3 hours</li> <li>Express Charge Boost Charge Method (Fast Charge for Initial 35%): From 0% up to 35% in as little as 20 minutes</li> </ul>

**Table 19. Battery specifications (continued)**

Description	Option one	Option two
in the Knowledge Base Resource at <a href="http://www.dell.com/support">www.dell.com/support</a> .	35%): From 0% up to 35% in as little as 20 minutes	
Coin-cell battery	Not supported	Not supported
<p><b>⚠ CAUTION: Operating and storage temperature ranges may differ among components, so operating or storing the device outside these ranges may impact the performance of specific components.</b></p> <p><b>⚠ CAUTION: Dell recommends that you charge the battery regularly for optimal power consumption. If your battery charge is completely depleted, connect the power adapter, turn on your computer, and then restart your computer to reduce the power consumption.</b></p>		

## Display

The following table lists the display specifications of your Dell G15 5530.

**Table 20. Display specifications**

Description	Option one	Option two	Option three	Option four
Display type	Full High Definition (FHD)	Full High Definition (FHD), ComfortView Plus	Full High Definition (FHD), ComfortView Plus	Quad-High Definition (QHD), ComfortView Plus
Touch options	No	No	No	No
Display-panel technology	Wide-Viewing Angle (WVA)	Wide-Viewing Angle (WVA)	Wide-Viewing Angle (WVA)	Wide-Viewing Angle (WVA)
Display-panel dimensions (active area):				
Height	193.59 mm (7.62 in.)	193.59 mm (7.62 in.)	193.59 mm (7.62 in.)	193.59 mm (7.62 in.)
Width	344.16 mm (13.55 in.)	344.16 mm (13.55 in.)	344.16 mm (13.55 in.)	344.16 mm (13.55 in.)
Diagonal	395 mm (15.60 in.)	395 mm (15.60 in.)	394.87 mm (15.60 in.)	394.87 mm (15.60 in.)
Display-panel native resolution	1920 x 1080	1920 x 1080	1920 x 1080	2560 x 1440
Luminance (typical)	250 nits	300 nits	300 nits	400 nits
Megapixels	2.07	2.07	2.07	3.68
Color gamut	45% NTSC (typical)	100% sRGB (typical)	100% sRGB (typical)	99% DCI-P3 (typical)
Pixels Per Inch (PPI)	141	141	141	188
Contrast ratio	<ul style="list-style-type: none"> <li>600:1 (minimum)</li> <li>800:1 (typical)</li> </ul>	<ul style="list-style-type: none"> <li>800:1 (minimum)</li> <li>1000:1 (typical)</li> </ul>	<ul style="list-style-type: none"> <li>800:1 (minimum)</li> <li>1000:1 (typical)</li> </ul>	<ul style="list-style-type: none"> <li>800:1 (minimum)</li> <li>1000:1 (typical)</li> </ul>
Response time	<ul style="list-style-type: none"> <li>Tr+Tf: 25 ms (typical)</li> <li>Tr+Tf: 35 ms (maximum)</li> </ul>	<ul style="list-style-type: none"> <li>GtG with Overdrive: 3 ms (typical)</li> <li>GtG without Overdrive: 8 ms (typical)</li> </ul>	GtG with Overdrive: 1 ms (typical)	GtG with Overdrive: 2 ms (typical)

**Table 20. Display specifications (continued)**

Description	Option one	Option two	Option three	Option four
Refresh rate	120 Hz	165 Hz	360 Hz	240 Hz
Horizontal view angle	+/- 85 degrees (typical)	+/- 85 degrees (typical)	+/- 85 degrees (typical)	+/- 85 degrees (typical)
Vertical view angle	+/- 85 degrees (typical)	+/- 85 degrees (typical)	+/- 85 degrees (typical)	+/- 85 degrees (typical)
Pixel pitch	0.17925 mm x 0.17925 mm	0.17925 mm x 0.17925 mm	0.17925 mm x 0.17925 mm	0.13446 mm x 0.13446 mm
Power consumption (maximum)	4.60 W	6 W	7.60 W	8.55 W
Anti-glare vs glossy finish	Anti-glare	Anti-glare	Anti-glare	Anti-glare

## GPU—Integrated

The following table lists the specifications of the integrated Graphics Processing Unit (GPU) supported by your Dell G15 5530.

**Table 21. GPU—Integrated**

Controller	Memory size	Processor
Intel UHD Graphics	Shared system memory	13 <sup>th</sup> Generation Intel Core i5/i7/i9

## GPU—Discrete

The following table lists the specifications of the discrete Graphics Processing Unit (GPU) supported by your Dell G15 5530.

**Table 22. GPU—Discrete**

Controller	Memory size	Memory type
NVIDIA GeForce RTX 3050	6 GB	DDR6
NVIDIA GeForce RTX 4050	6 GB	DDR6
NVIDIA GeForce RTX 4060	8 GB	DDR6

## Operating and storage environment

This table lists the operating and storage specifications of your Dell G15 5530.

**Airborne contaminant level:** G1 as defined by ISA-S71.04-1985

**Table 23. Computer environment**

Description	Operating	Storage
Temperature range	0°C to 35°C (32°F to 95°F)	-40°C to 65°C (-40°F to 149°F)
Relative humidity (maximum)	10% to 90% (non-condensing)	0% to 95% (non-condensing)
Vibration (maximum)*	0.66 GRMS	1.30 GRMS



**Table 23. Computer environment (continued)**

Description	Operating	Storage
Shock (maximum)	110 G†	160 G†
Altitude range	-15.2 m to 3048 m (4.64 ft to 5518.4 ft)	-15.2 m to 10668 m (4.64 ft to 19234.4 ft)
 <b>CAUTION: Operating and storage temperature ranges may differ among components, so operating or storing the device outside these ranges may impact the performance of specific components.</b>		

\* Measured using a random vibration spectrum that simulates user environment.

† Measured using a 2 ms half-sine pulse.

## ComfortView Plus

 **WARNING: Prolonged exposure to blue light from the display may lead to long-term effects such as eye strain, eye fatigue, or damage to the eyes.**

Blue light is a color in the light spectrum which has a short wavelength and high energy. Chronic exposure to blue light, particularly from digital sources, may disrupt sleep patterns and cause long-term effects such as eye strain, eye fatigue, or damage to the eyes.

The display on this computer is designed to minimize blue light and complies with TÜV Rheinland's requirement for low blue light displays.

Low blue light mode is enabled at the factory, so no further configuration is necessary.











To reduce the risk of eye strain, it is also recommended that you:

- Position the display at a comfortable viewing distance between 20 and 28 inches (50 and 70 cm) from your eyes.
- Blink frequently to moisten your eyes, wet your eyes with water, or apply suitable eye drops.
- Look away from your display, and gaze at a distant object at 20 ft (609.60 cm) away for at least 20 seconds during each break.
- Take an extended break for 20 minutes every two hours.

# Working inside your computer

## Safety instructions

Use the following safety guidelines to protect your computer from potential damage and to ensure your personal safety. Unless otherwise noted, each procedure included in this document assumes that you have read the safety information that shipped with your computer.

-  **WARNING:** Before working inside your computer, read the safety information that is shipped with your computer. For more safety best practices, see the Regulatory Compliance home page at [www.dell.com/regulatory\\_compliance](http://www.dell.com/regulatory_compliance).
-  **WARNING:** Disconnect your computer from all power sources before opening the computer cover or panels. After you finish working inside the computer, replace all covers, panels, and screws before connecting your computer to an electrical outlet.
-  **CAUTION:** To avoid damaging the computer, ensure that the work surface is flat, dry, and clean.
-  **CAUTION:** To avoid damaging the components and cards, handle them by their edges, and avoid touching the pins and the contacts.
-  **CAUTION:** You should only perform troubleshooting and repairs as authorized or directed by the Dell technical assistance team. Damage due to servicing that is not authorized by Dell is not covered by your warranty. See the safety instructions that is shipped with the product or at [www.dell.com/regulatory\\_compliance](http://www.dell.com/regulatory_compliance).
-  **CAUTION:** Before touching anything inside your computer, ground yourself by touching an unpainted metal surface, such as the metal at the back of the computer. While you work, periodically touch an unpainted metal surface to dissipate static electricity which could harm internal components.
-  **CAUTION:** When you disconnect a cable, pull it by its connector or its pull tab, not the cable itself. Some cables have connectors with locking tabs or thumbscrews that you must disengage before disconnecting the cable. When disconnecting cables, keep them evenly aligned to avoid bending the connector pins. When connecting cables, ensure that the ports and the connectors are correctly oriented and aligned.
-  **CAUTION:** Press and eject any installed card from the media-card reader.
-  **CAUTION:** Exercise caution when handling rechargeable Li-ion batteries in laptops. Swollen batteries should not be used and should be replaced and disposed properly.
-  **NOTE:** The color of your computer and certain components may appear differently than shown in this document.

## Before working inside your computer

### About this task

-  **NOTE:** The images in this document may differ from your computer depending on the configuration you ordered.

### Steps

1. Save and close all open files and exit all open applications.
2. Shut down your computer. For Windows operating system, click **Start** >  **Power** > **Shut down**.

 **NOTE:** If you are using a different operating system, see the documentation of your operating system for shut-down instructions.

3. Disconnect your computer and all attached devices from their electrical outlets.
4. Disconnect all attached network devices and peripherals, such as keyboard, mouse, and monitor from your computer.

 **CAUTION:** To disconnect a network cable, first unplug the cable from your computer and then unplug the cable from the network device.

5. Remove any media card and optical disc from your computer, if applicable.

## Safety precautions

The safety precautions chapter details the primary steps to be taken before performing any disassembly instructions.

Observe the following safety precautions before you perform any installation or break/fix procedures involving disassembly or reassembly:

- Turn off the system and all attached peripherals.
- Disconnect the system and all attached peripherals from AC power.
- Disconnect all network cables, telephone, and telecommunications lines from the system.
- Use an ESD field service kit when working inside any to avoid electrostatic discharge (ESD) damage.
- After removing any system component, carefully place the removed component on an anti-static mat.
- Wear shoes with non-conductive rubber soles to reduce the chance of getting electrocuted.

## Standby power

Dell products with standby power must be unplugged before you open the case. Systems that incorporate standby power are essentially powered while turned off. The internal power enables the system to be remotely turned on (wake on LAN) and suspended into a sleep mode and has other advanced power management features.

Unplugging, pressing, and holding the power button for 15 seconds should discharge residual power in the system board.

## Bonding

Bonding is a method for connecting two or more grounding conductors to the same electrical potential. This is done through the use of a field service electrostatic discharge (ESD) kit. When connecting a bonding wire, ensure that it is connected to bare metal and never to a painted or non-metal surface. The wrist strap should be secure and in full contact with your skin, and ensure that you remove all jewelry such as watches, bracelets, or rings prior to bonding yourself and the equipment.

## Electrostatic discharge—ESD protection

ESD is a major concern when you handle electronic components, especially sensitive components such as expansion cards, processors, memory DIMMs, and system boards. Very slight charges can damage circuits in ways that may not be obvious, such as intermittent problems or a shortened product life span. As the industry pushes for lower power requirements and increased density, ESD protection is an increasing concern.

Due to the increased density of semiconductors used in recent Dell products, the sensitivity to static damage is now higher than in previous Dell products. For this reason, some previously approved methods of handling parts are no longer applicable.

Two recognized types of ESD damage are catastrophic and intermittent failures.

- **Catastrophic** – Catastrophic failures represent approximately 20 percent of ESD-related failures. The damage causes an immediate and complete loss of device functionality. An example of catastrophic failure is a memory DIMM that has received a static shock and immediately generates a "No POST/No Video" symptom with a beep code emitted for missing or nonfunctional memory.
- **Intermittent** – Intermittent failures represent approximately 80 percent of ESD-related failures. The high rate of intermittent failures means that most of the time when damage occurs, it is not immediately recognizable. The DIMM receives a static shock, but the tracing is merely weakened and does not immediately produce outward symptoms related to the damage. The weakened trace may take weeks or months to melt, and in the meantime may cause degradation of memory integrity, intermittent memory errors, etc.

The more difficult type of damage to recognize and troubleshoot is the intermittent (also called latent or "walking wounded") failure.

Perform the following steps to prevent ESD damage:

- Use a wired ESD wrist strap that is properly grounded. The use of wireless anti-static straps is no longer allowed; they do not provide adequate protection. Touching the chassis before handling parts does not ensure adequate ESD protection on parts with increased sensitivity to ESD damage.
- Handle all static-sensitive components in a static-safe area. If possible, use anti-static floor pads and workbench pads.
- When unpacking a static-sensitive component from its shipping carton, do not remove the component from the anti-static packing material until you are ready to install the component. Before unwrapping the anti-static packaging, ensure that you discharge static electricity from your body.
- Before transporting a static-sensitive component, place it in an anti-static container or packaging.

## ESD field service kit

The unmonitored Field Service kit is the most commonly used service kit. Each Field Service kit includes three main components: anti-static mat, wrist strap, and bonding wire.

### Components of an ESD field service kit

The components of an ESD field service kit are:

- **Anti-Static Mat** – The anti-static mat is dissipative and parts can be placed on it during service procedures. When using an anti-static mat, your wrist strap should be snug and the bonding wire should be connected to the mat and to any bare metal on the system being worked on. Once deployed properly, service parts can be removed from the ESD bag and placed directly on the mat. ESD-sensitive items are safe in your hand, on the ESD mat, in the system, or inside a bag.
- **Wrist Strap and Bonding Wire** – The wrist strap and bonding wire can be either directly connected between your wrist and bare metal on the hardware if the ESD mat is not required, or connected to the anti-static mat to protect hardware that is temporarily placed on the mat. The physical connection of the wrist strap and bonding wire between your skin, the ESD mat, and the hardware is known as bonding. Use only Field Service kits with a wrist strap, mat, and bonding wire. Never use wireless wrist straps. Always be aware that the internal wires of a wrist strap are prone to damage from normal wear and tear, and must be checked regularly with a wrist strap tester in order to avoid accidental ESD hardware damage. It is recommended to test the wrist strap and bonding wire at least once per week.
- **ESD Wrist Strap Tester** – The wires inside of an ESD strap are prone to damage over time. When using an unmonitored kit, it is a best practice to regularly test the strap prior to each service call, and at a minimum, test once per week. A wrist strap tester is the best method for doing this test. If you do not have your own wrist strap tester, check with your regional office to find out if they have one. To perform the test, plug the wrist-strap's bonding-wire into the tester while it is strapped to your wrist and push the button to test. A green LED is lit if the test is successful; a red LED is lit and an alarm sounds if the test fails.
- **Insulator Elements** – It is critical to keep ESD sensitive devices, such as plastic heat sink casings, away from internal parts that are insulators and often highly charged.
- **Working Environment** – Before deploying the ESD Field Service kit, assess the situation at the customer location. For example, deploying the kit for a server environment is different than for a desktop or portable environment. Servers are typically installed in a rack within a data center; desktops or portables are typically placed on office desks or cubicles. Always look for a large open flat work area that is free of clutter and large enough to deploy the ESD kit with additional space to accommodate the type of system that is being repaired. The workspace should also be free of insulators that can cause an ESD event. On the work area, insulators such as Styrofoam and other plastics should always be moved at least 12 inches or 30 centimeters away from sensitive parts before physically handling any hardware components
- **ESD Packaging** – All ESD-sensitive devices must be shipped and received in static-safe packaging. Metal, static-shielded bags are preferred. However, you should always return the damaged part using the same ESD bag and packaging that the new part arrived in. The ESD bag should be folded over and taped shut and all the same foam packing material should be used in the original box that the new part arrived in. ESD-sensitive devices should be removed from packaging only at an ESD-protected work surface, and parts should never be placed on top of the ESD bag because only the inside of the bag is shielded. Always place parts in your hand, on the ESD mat, in the system, or inside an anti-static bag.
- **Transporting Sensitive Components** – When transporting ESD sensitive components such as replacement parts or parts to be returned to Dell, it is critical to place these parts in anti-static bags for safe transport.

## ESD protection summary

It is recommended to use the traditional wired ESD grounding wrist strap and protective anti-static mat at all times when servicing Dell products. In addition, it is critical to keep sensitive parts separate from all insulator parts while performing service and that they use anti-static bags for transporting sensitive components.

## Transporting sensitive components

When transporting ESD sensitive components such as replacement parts or parts to be returned to Dell, it is critical to place these parts in anti-static bags for safe transport.

## After working inside your computer

### About this task

 **NOTE:** Leaving stray or loose screws inside your computer may severely damage your computer.

### Steps

1. Replace all screws and ensure that no stray screws remain inside your computer.
2. Connect any external devices, peripherals, or cables you removed before working on your computer.
3. Replace any media cards, discs, or any other parts that you removed before working on your computer.
4. Connect your computer and all attached devices to their electrical outlets.
5. Turn on your computer.

## BitLocker

 **CAUTION:** If BitLocker is not suspended before updating the BIOS, the next time you reboot the system it will not recognize the BitLocker key. You will then be prompted to enter the recovery key to progress, and the system will ask for this on each reboot. If the recovery key is not known this can result in data loss or an unnecessary operating system reinstall. For more information about this subject, see Knowledge Article: [updating the BIOS on Dell systems with BitLocker enabled](#).

The installation of the following components triggers BitLocker:

- Hard disk drive or solid state drive
- System board

## Recommended tools

The procedures in this document may require the following tools:

- Phillips screwdriver #0
- Phillips screwdriver #1
- Plastic scribe



















## Screw list

 **NOTE:** When removing screws from a component, it is recommended to note the screw type, the quantity of screws, and then place them in a screw storage box. This is to ensure that the correct number of screws and correct screw type is restored when the component is replaced.





 **NOTE:** Some computers have magnetic surfaces. Ensure that the screws are not left attached to such surfaces when replacing a component.

**NOTE:** Screw color may vary with the configuration ordered.

**Table 24. Screw list**

Component	Screw type	Quantity	Screw image
Base cover	M2x5	6	
Battery	M2x4	4	
Solid-state drive (SSD slot 1)	M2x4	2	
Solid-state drive (SSD slot 2)	M2x4	2	
Wireless card	M2x4	1	
Touchpad bracket	M2x2	3	
Touchpad	M2x2	4	
Rear cover	M2x4	2	
Rear cover	M2x5	4	
Display hinges	M2.5x4	8	
Keyboard-controller board	M2x2	1	
Power-adaptor port	M2x5	2	
System board	M2x5	7	
System board	M2x4	1	
USB board	M2x4	2	
USB board	M2x3	1	
Ethernet and audio board	M2x4	2	
Ethernet and audio board	M2x3	1	

**Table 24. Screw list (continued)**

<b>Component</b>	<b>Screw type</b>	<b>Quantity</b>	<b>Screw image</b>
Left fan (fan and heat-sink assembly)	M2x4	1	
Fan and heat-sink assembly	M2x4	6	
Power-button board bracket	M2x2	2	
Power button	M2x2	1	

## Major components of Dell G15 5530

The following image shows the major components of Dell G15 5530.

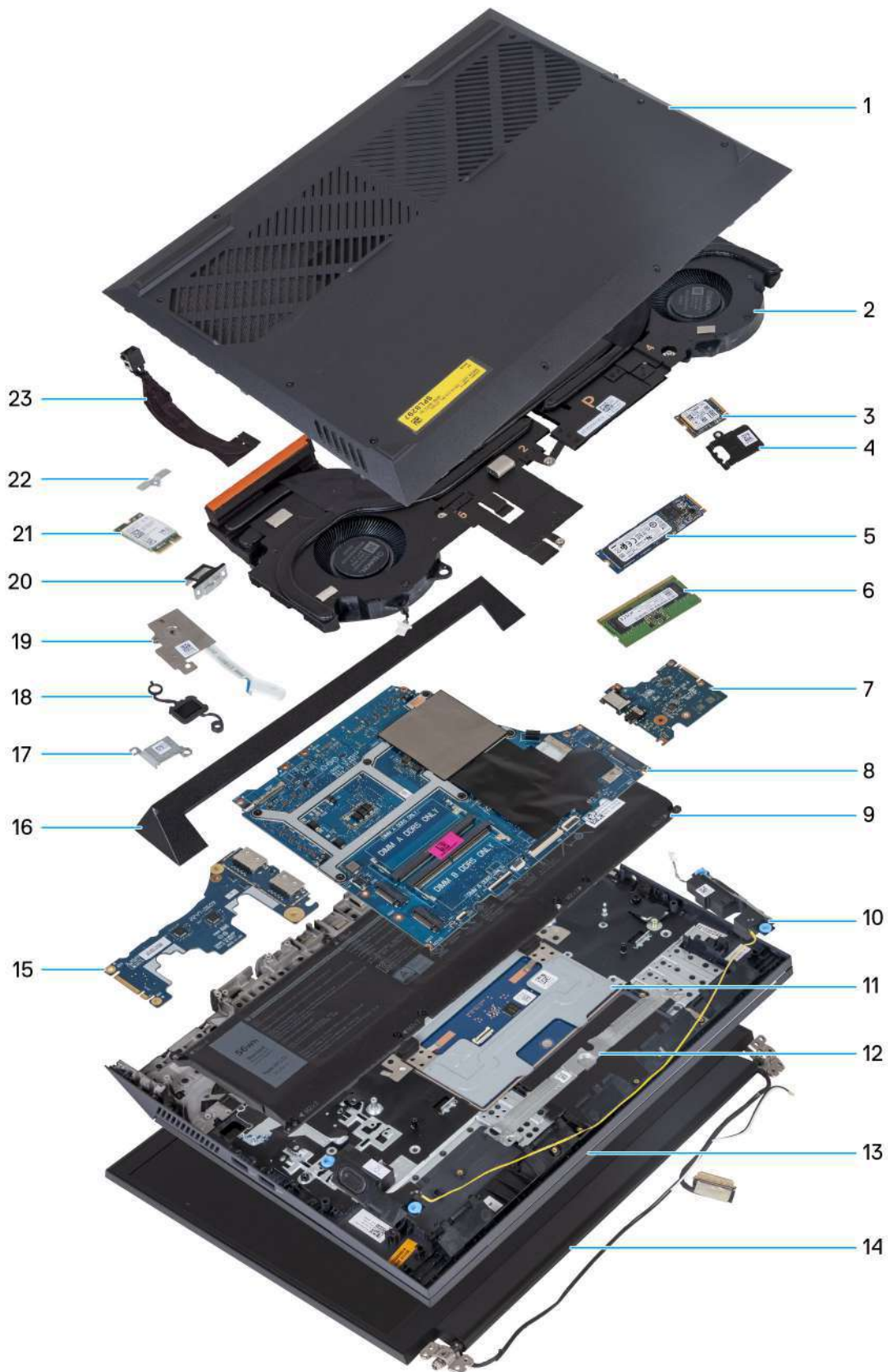

- |                             |   |
|-----------------------------|---|
| 1. Base cover               | 2. Fan and heat-sink assembly           |
| 3. M.2 solid-state drive    | 4. M.2 solid-state drive thermal shield |
| 5. M.2 solid-state drive    | 6. Memory module                        |
| 7. Ethernet and audio board | 8. System board                         |



- 9. Battery
- 11. Touchpad
- 13. Palm-rest and keyboard assembly
- 15. USB board
- 17. Power-adaptor port bracket
- 19. Power-button board
- 21. Wireless card
- 23. Power-adaptor port
- 10. Speakers
- 12. Touchpad bracket
- 14. Display assembly
- 16. Rear cover
- 18. Power button
- 20. Type-C bracket
- 22. Wireless-card bracket

 **NOTE:** Dell provides a list of components and their part numbers for the original system configuration purchased. These parts are available according to warranty coverages purchased by the customer. Contact your Dell sales representative for purchase options.

# Removing and installing Customer Replaceable Units (CRUs)

The replaceable components in this chapter are Customer Replaceable Units (CRUs).

 **CAUTION:** Customers can replace only the Customer Replaceable Units (CRUs) following the safety precautions and replacement procedures.

 **NOTE:** The images in this document may differ from your computer depending on the configuration you ordered.

## Base cover

### Removing the base cover

#### Prerequisites

1. Follow the procedure in [Before working inside your computer](#).

#### About this task

The following images indicate the location of the base cover and provide a visual representation of the removal procedure.



6x  
M2x5



4x



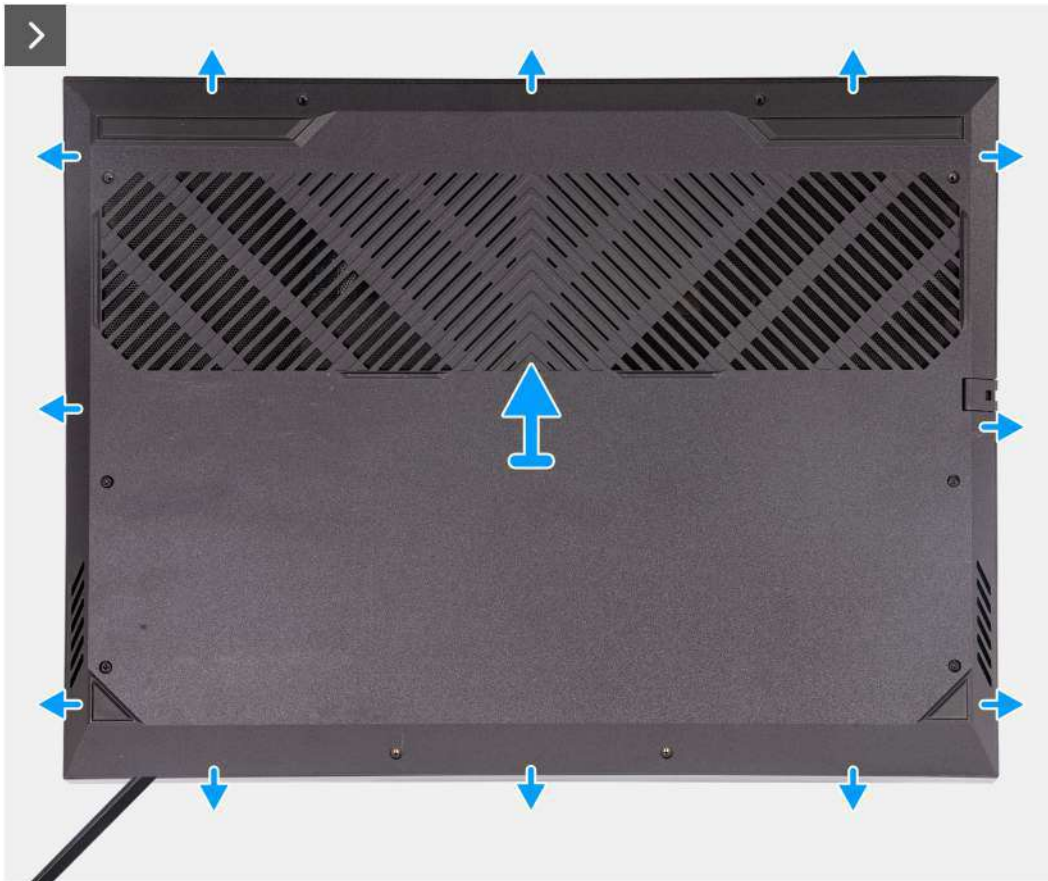

### Steps

1. Remove the six screws (M2x5) that secure the base cover to the palm-rest and keyboard assembly.
2. Loosen the four captive screws that secure the base cover to the palm-rest and keyboard assembly.
  - NOTE:** Loosening the two captive screws located in the front of the computer creates a gap which can be used to pry and lift the base cover off the palm-rest and keyboard assembly.
3. Starting from the gap created at the left-bottom corner, pry open the base cover. Work your way around the bottom edge and bottom-right corner of the base cover.
4. Lift the base cover off the palm-rest and keyboard assembly.
  - NOTE:** The following steps are applicable only if you want to further remove any other component from your computer.
5. Using the pull tab, disconnect the battery cable from the system board.
6. Turn your computer over and press the power button for 20 seconds to drain the flea power.

# Installing the base cover

## Prerequisites

If you are replacing a component, remove the existing component before performing the installation procedure.

## About this task

The following images indicate the location of the base cover and provide a visual representation of the installation procedure.

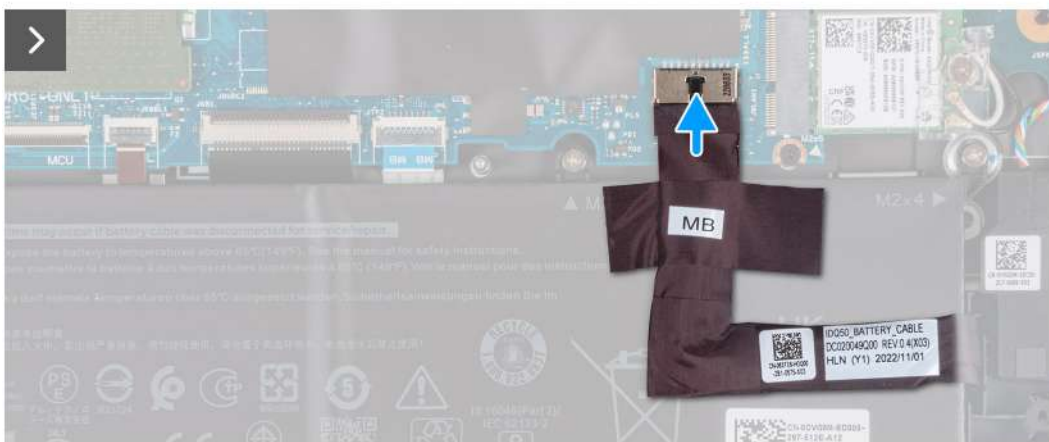

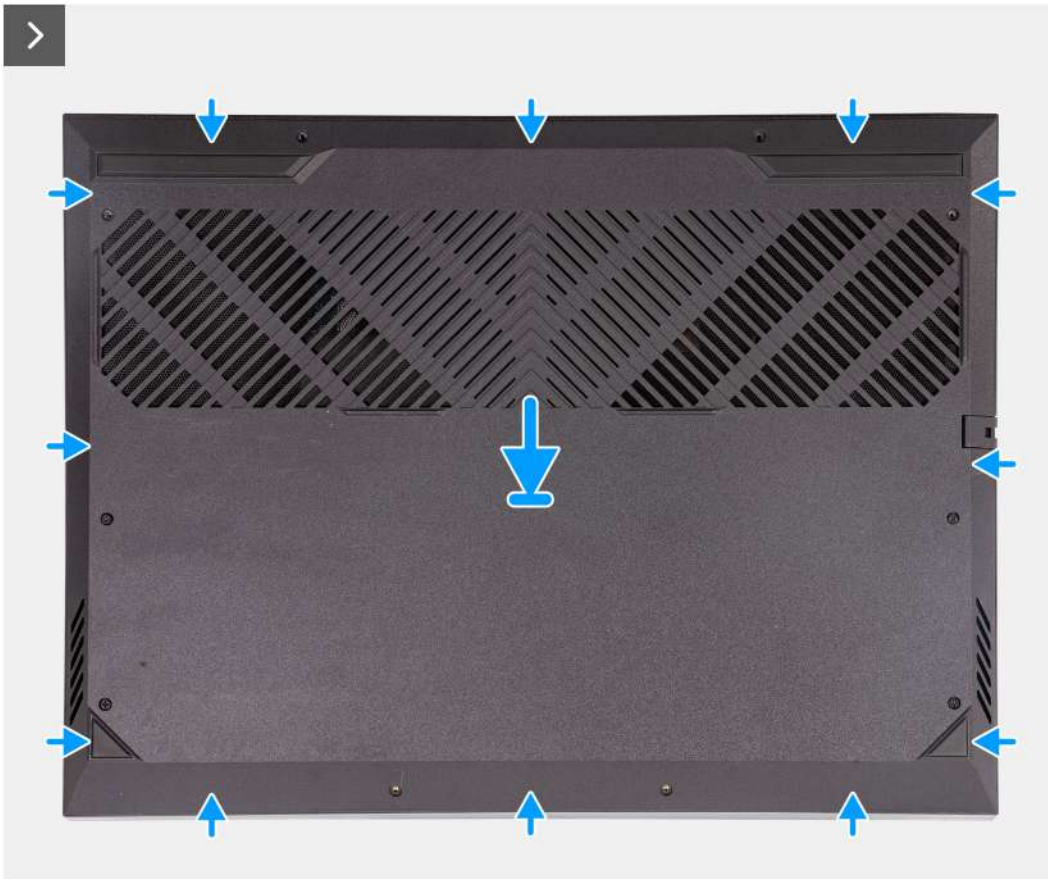



### Steps

1. Connect the battery cable to the system board, if the battery cable had been previously disconnected.
2. Align the screw holes on the base cover with the screw holes on the palm-rest and keyboard assembly, and then snap the base cover into place.
3. Replace the six screws (M2x5) that secure the base cover to the palm-rest and keyboard assembly.
4. Tighten the four captive screws that secure the base cover to the palm-rest and keyboard assembly.

### Next steps

1. Follow the procedure in [After working inside your computer](#).

## Solid-state drive

### Removing the solid-state drive

#### Prerequisites

1. Follow the procedure in [Before working inside your computer](#).
2. Remove the [base cover](#).

#### About this task

**NOTE:** Your computer has two M.2 solid-state drive slots, both located on the system board adjacent to the left fan. The procedure to remove a solid-state drive from slot 1 and slot 2 are exactly the same.

**NOTE:** Depending on the configuration ordered, a 2230 or 2280 solid-state drive may be installed in your computer.

The following image(s) indicates the location of M.2 2230 solid-state drive or the M.2 2280 solid-state drive and provides a visual representation of their respective removal procedures.

#### Removing the M.2 2230 solid-state drive

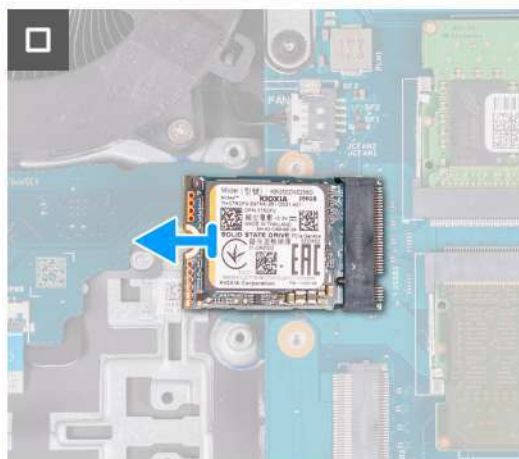
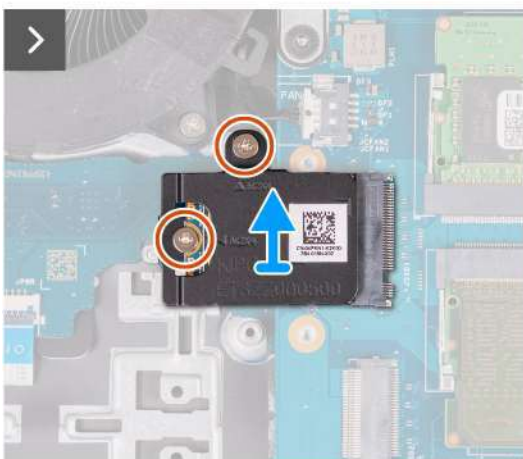

#### Removing the M.2 2280 solid-state drive

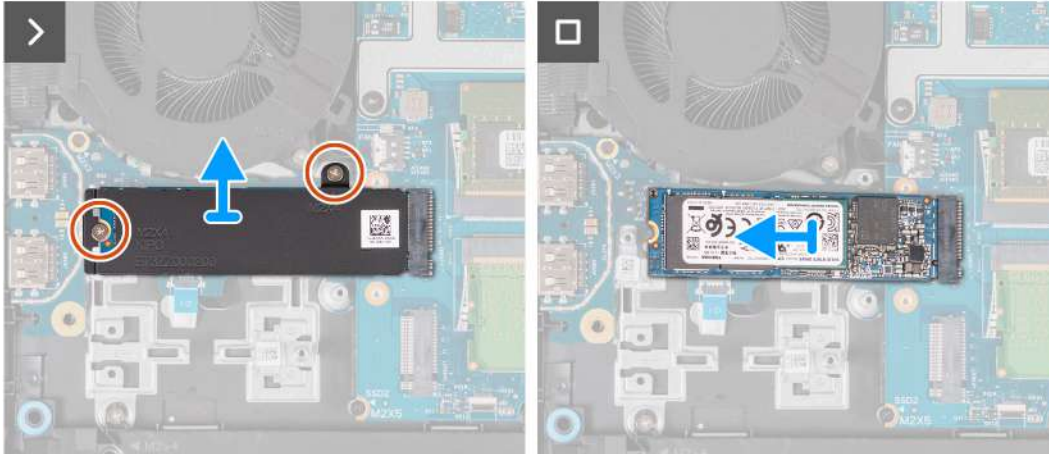
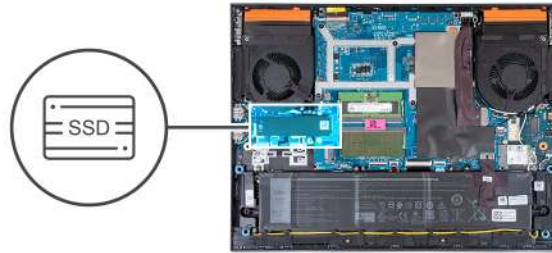

### Steps

1. Remove the two screws (M2x4) that secure the thermal shield to the solid-state drive and the system board.
2. Lift the thermal shield off the palm-rest and keyboard assembly.
3. Slide and lift the solid-state drive off the M.2 slot on the system board.

## Installing the solid-state drive

### Prerequisites

If you are replacing a component, remove the existing component before performing the installation procedure.

### About this task

- i** **NOTE:** Your computer has two M.2 solid-state drive slots, both located on the system board adjacent to the left fan. The procedure to remove a solid-state drive from slot 1 and slot 2 are exactly the same.
- i** **NOTE:** Depending on the configuration ordered, a M.2 2230 or 2280 solid-state drive may be installed into both slot 1 and 2. If you are installing a solid-state drive into **slot 2** by yourself, only a **M.2 2280 SSD**, paired with a **Dell thermal shield** is recommended.

The following image(s) indicates the location of the M.2 2230 solid-state drive or the M.2 2280 solid-state drive and provides a visual representation of their respective installation procedures.

### Installing the M.2 2230 solid-state drive





2x  
M2x4

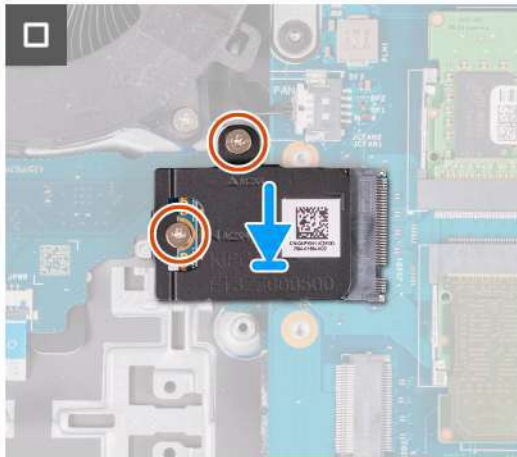

### Installing the M.2 2280 solid-state drive



2x  
M2x4

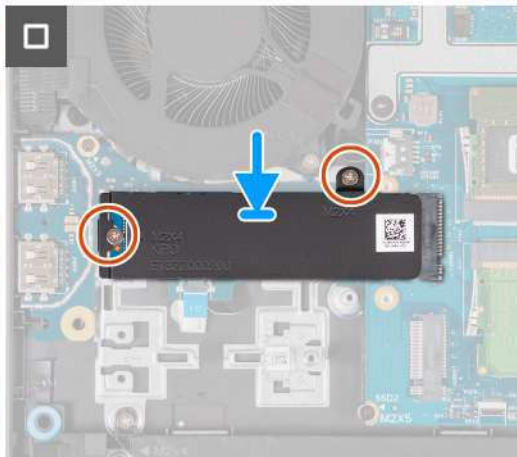
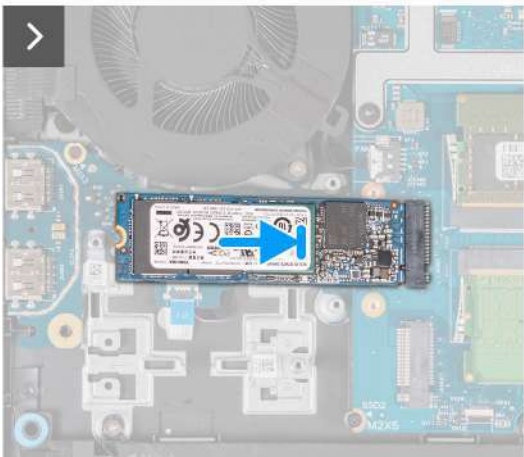

### Steps

1. Align the notch on the solid-state drive with the tab on the M.2 card slot.
2. Slide the solid-state drive into the M.2 card slot.
3. Place the thermal shield on the solid-state drive.
4. Align the screw holes on the thermal shield with the screw holes on the solid-state drive and system board.
5. Replace the two screws (M2x4) that secure the thermal shield to the solid-state drive and the system board.

### Next steps

1. Install the [base cover](#).
2. Follow the procedure in [After working inside your computer](#).

## Wireless card

### Removing the wireless card

#### Prerequisites

1. Follow the procedure in [Before working inside your computer](#).
2. Remove the [base cover](#).

#### About this task

The following image indicates the location of the wireless card and provides a visual representation of the removal procedure.



1x  
M2x4

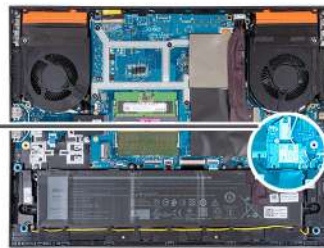

#### Steps

1. Remove the screw (M2x4) that secures the wireless card to the system board.
2. Lift the bracket off the wireless card.
3. Disconnect the antenna cables from the wireless card.
4. Slide and remove the wireless card from the M.2 wireless card slot.

# Installing the wireless card

## Prerequisites

If you are replacing a component, remove the existing component before performing the installation procedure.

## About this task

The following image indicates the location of the wireless card and provides a visual representation of the installation procedure.

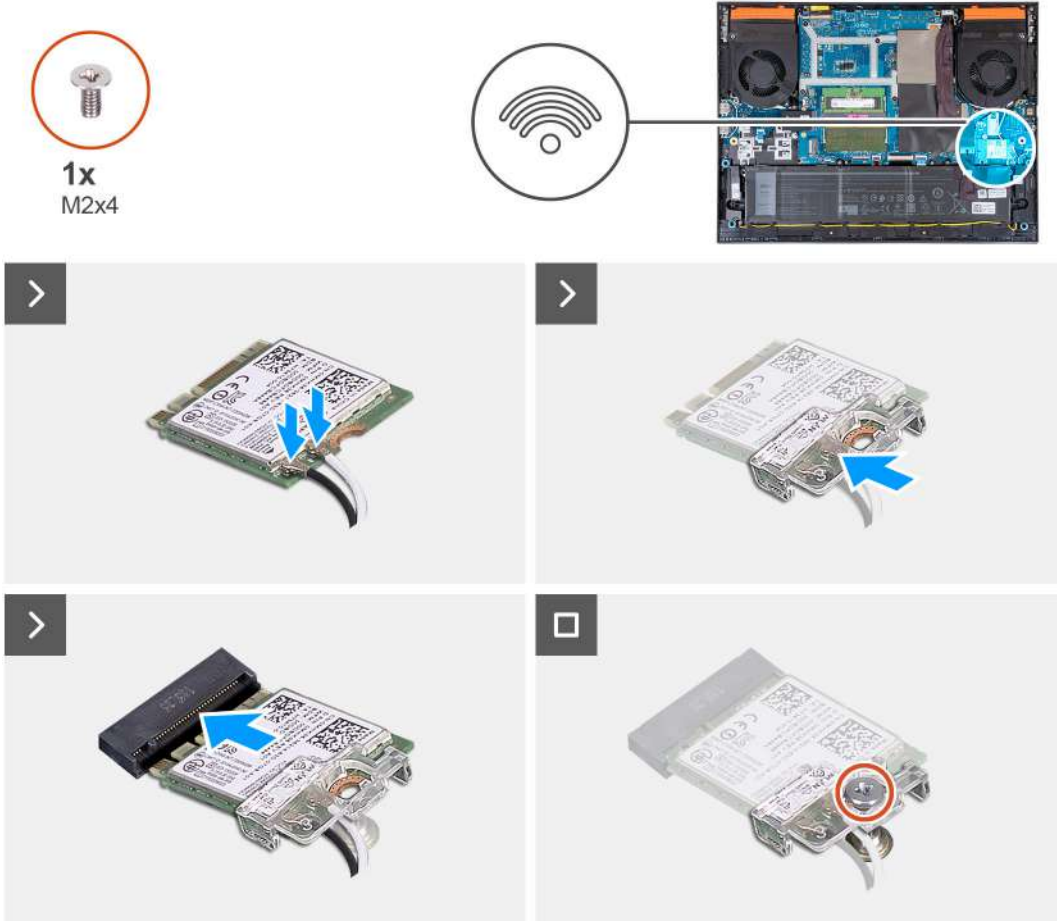

## Steps

1. Connect the antenna cables to the wireless card.

The following table provides the antenna-cable color scheme for the wireless card supported by your computer.

**Table 25. Antenna-cable color scheme**

Connectors on the wireless card	Antenna-cable color
Main (white triangle)	White
Auxiliary (black triangle)	Black

2. Align the notch on the wireless card with the tab on the M.2 wireless card slot and insert the wireless card at an angle into the M.2 card slot.
3. Place and align the wireless-card bracket on the wireless card.
4. Replace the screw (M2x4) that secures the wireless card to the system board.

### Next steps

1. Install the [base cover](#).
2. Follow the procedure in [After working inside your computer](#).

## Memory

### Removing the memory module

#### Prerequisites

1. Follow the procedure in [Before working inside your computer](#).
2. Remove the [base cover](#).

#### About this task

The following image indicates the location of the memory modules and provides a visual representation of the removal procedure.

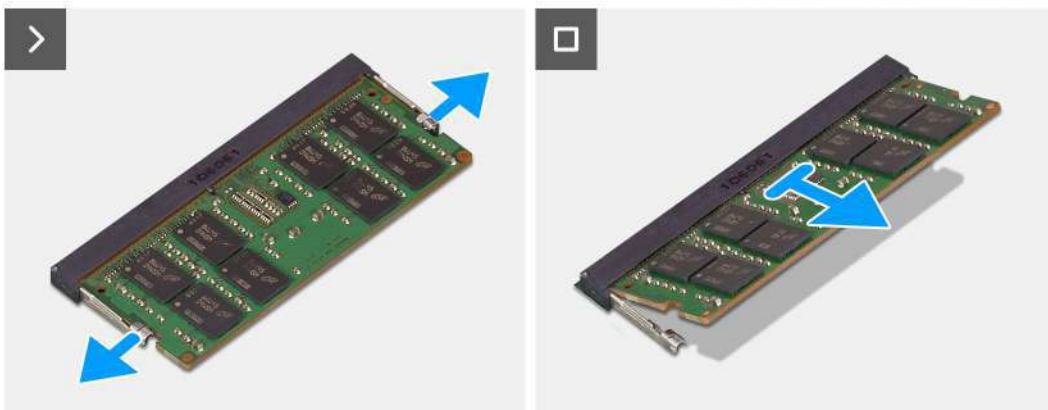
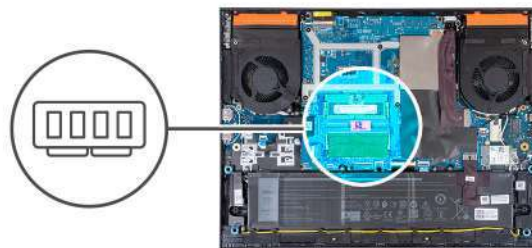

#### Steps

1. Use your fingertips to carefully spread apart the securing-clips on each end of the memory-module slot until the memory module pops up.
2. Remove the memory module from the memory-module slot.

**i** **NOTE:** Repeat step 1 and step 2 if there is a second memory module installed on your computer.

### Installing the memory module

#### Prerequisites

If you are replacing a component, remove the existing component before performing the installation procedure.

### About this task

The following image indicates the location of the memory module and provides a visual representation of the installation procedure.

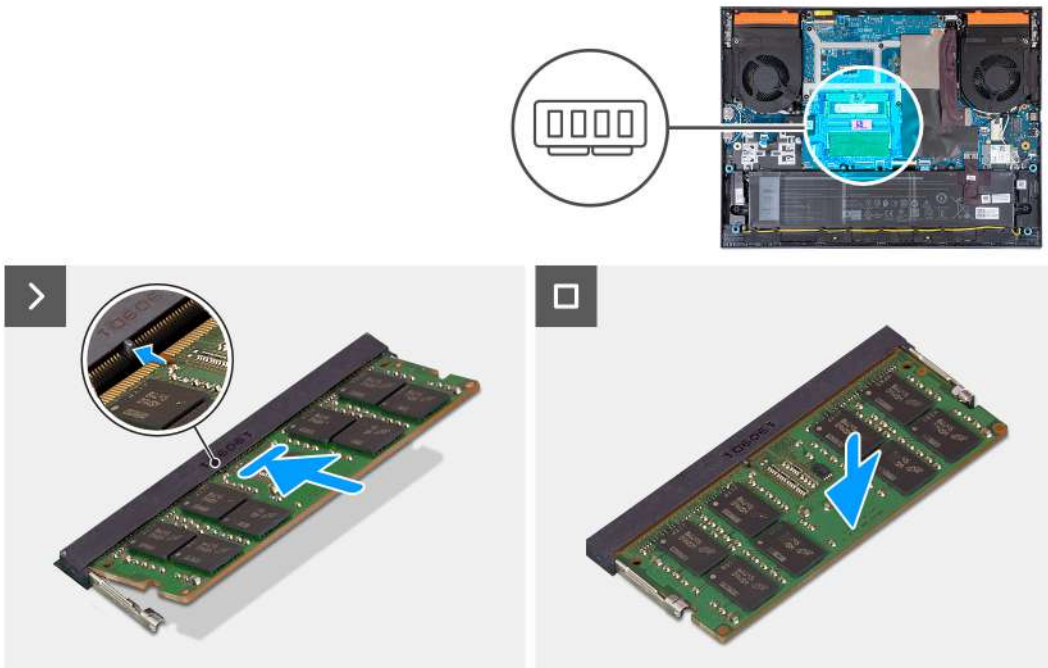

### Steps

1. Align the notch on the memory module with the tab on the memory-module slot.
2. Slide the memory module into the memory-module slot.
3. Press the memory module down until it clicks into place.

**i** | **NOTE:** If you do not hear the click, remove the memory module and reinstall it.

**i** | **NOTE:** Repeat step 1 to step 3 to install a second memory module into your computer, if applicable.

### Next steps

1. Install the [base cover](#).
2. Follow the procedure in [After working inside your computer](#).

## Speakers

### Removing the speakers

#### Prerequisites

1. Follow the procedure in [Before working inside your computer](#).
2. Remove the [base cover](#).

### About this task

The following image indicates the location of the speakers and provides a visual representation of the removal procedure.



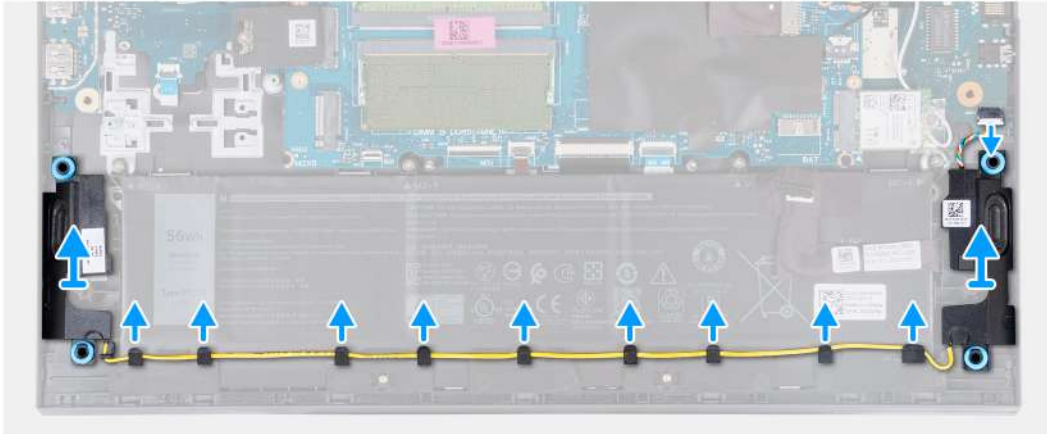
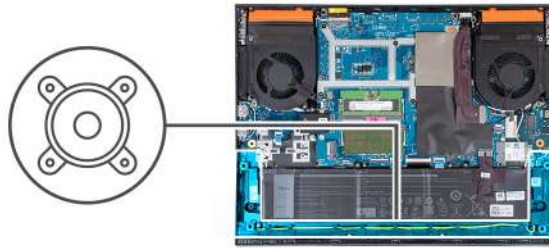

### Steps

1. Disconnect the speaker cable from the ethernet and audio board.
2. Remove the speaker cable from the routing guides along the bottom edge of the palm-rest and keyboard assembly.
3. Lift the speakers, along with its cable, off the palm-rest and keyboard assembly.

## Installing the speakers

### Prerequisites

If you are replacing a component, remove the existing component before performing the installation procedure.

### About this task

The following image indicates the location of the speakers and provides a visual representation of the installation procedure.

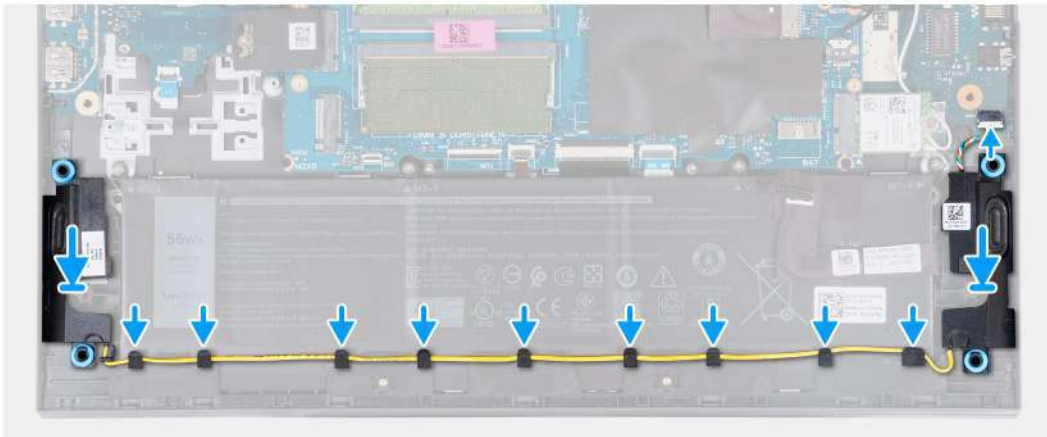
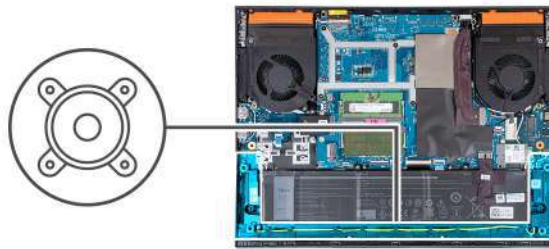

### Steps

1. Using the alignment posts and rubber grommets, place the speakers in the slots on the palm-rest and keyboard assembly  
**NOTE:** If the rubber grommets are pushed out of the speakers when removing the speakers, push them back in place before replacing the speakers.
2. Connect the speaker cable to the ethernet and audio board.
3. Route the speaker cable through the routing guides on the palm-rest and keyboard assembly.

### Next steps

1. Install the [base cover](#).
2. Follow the procedure in [After working inside your computer](#).

## Rear cover

### Removing the rear cover

#### Prerequisites

1. Follow the procedure in [Before working inside your computer](#).
2. Remove the [base cover](#).

#### About this task

The following image indicates the location of the rear cover and provides a visual representation of the removal procedure.

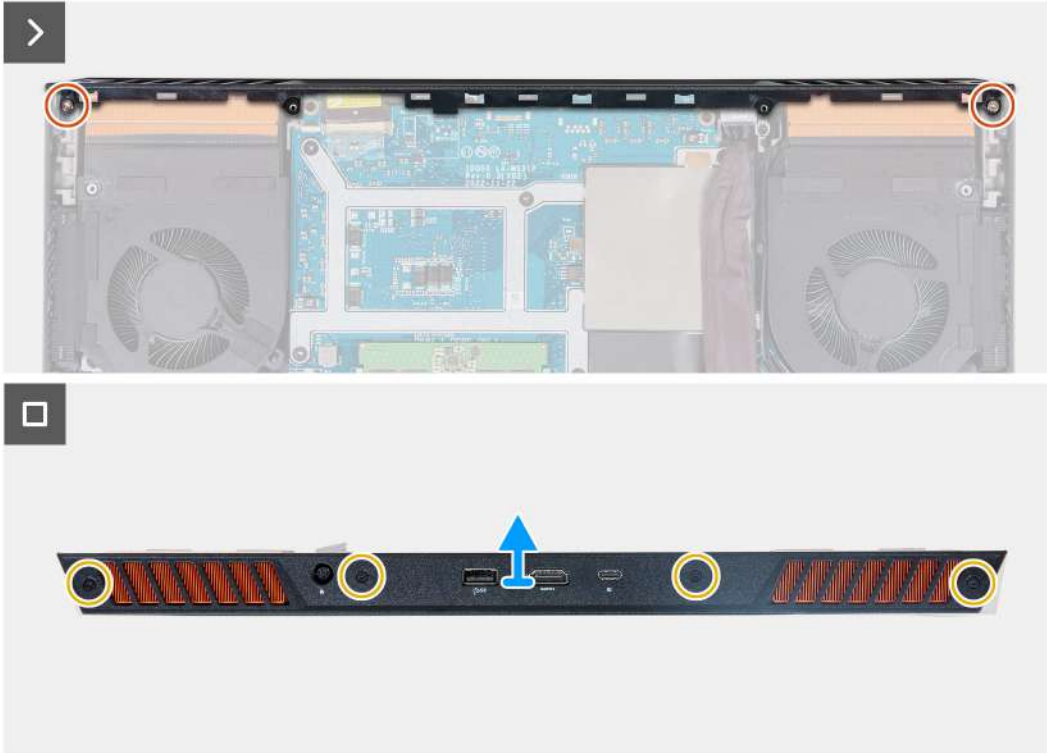

### Steps

1. Remove the two screws (M2x4) that secure the rear cover to the system board.
2. Remove the four screws (M2x5) that secure the rear cover to the palm-rest and keyboard assembly.
3. Push the rear cover away from the system board and lift it off the palm-rest and keyboard assembly.

## Installing the rear cover

### Prerequisites

If you are replacing a component, remove the existing component before performing the installation procedure.

### About this task

The following image indicates the location of the rear cover and provides a visual representation of the installation procedure.



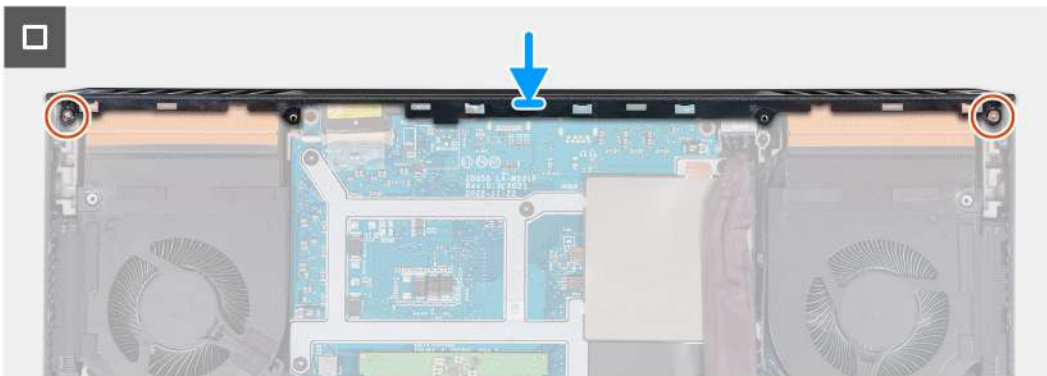

### Steps

1. Slide the rear cover towards the system board till it snaps into place.
2. Align the screw holes on the rear cover with the screw holes on the palm-rest and keyboard assembly.
3. Replace the four screws (M2x5) that secure the rear cover to the system board.
4. Replace the two screws (M2x4) that secure the rear cover to the palm-rest and keyboard assembly.

### Next steps

1. Install the [base cover](#).
2. Follow the procedure in [After working inside your computer](#).

# Removing and installing Field Replaceable Units (FRUs)

The replaceable components in this chapter are Field Replaceable Units (FRUs).

**CAUTION:** The information in this section is intended for authorized service technicians only.

**CAUTION:** To avoid any potential damage to the component or loss of data, ensure that an authorized service technician replaces the Field Replaceable Units (FRUs).

**CAUTION:** Dell Technologies recommends that this set of repairs, if needed, to be conducted by trained technical repair specialists.

**CAUTION:** As a reminder, your warranty does not cover damages that may occur during the courses of FRU repairs that are not authorized by Dell Technologies.

**NOTE:** The images in this document may differ from your computer depending on the configuration you ordered.

## Battery

### Rechargeable Li-ion battery precautions

**CAUTION:**

- Exercise caution when handling rechargeable Li-ion batteries.
- Discharge the battery completely before removing it. Disconnect the AC power adapter from the system and operate the computer solely on battery power—the battery is fully discharged when the computer no longer turns on when the power button is pressed.
- Do not crush, drop, mutilate, or penetrate the battery with foreign objects.
- Do not expose the battery to high temperatures, or disassemble battery packs and cells.
- Do not apply pressure to the surface of the battery.
- Do not bend the battery.
- Do not use tools of any kind to pry on or against the battery.
- Ensure any screws during the servicing of this product are not lost or misplaced, to prevent accidental puncture or damage to the battery and other system components.
- If the battery gets stuck inside your computer as a result of swelling, do not try to release it as puncturing, bending, or crushing a rechargeable Li-ion battery can be dangerous. In such an instance, contact Dell technical support for assistance. See [www.dell.com/contactdell](http://www.dell.com/contactdell).
- Always purchase genuine batteries from [www.dell.com](http://www.dell.com) or authorized Dell partners and resellers.
- Swollen batteries should not be used and should be replaced and disposed properly. For guidelines on how to handle and replace swollen rechargeable Li-ion batteries, see [Handling swollen rechargeable Li-ion batteries](#).

## Removing the battery

### Prerequisites

1. Follow the procedure in [Before working inside your computer](#).
2. Remove the [base cover](#).

### About this task

The following image indicates the location of the battery and provides a visual representation of the removal procedure.

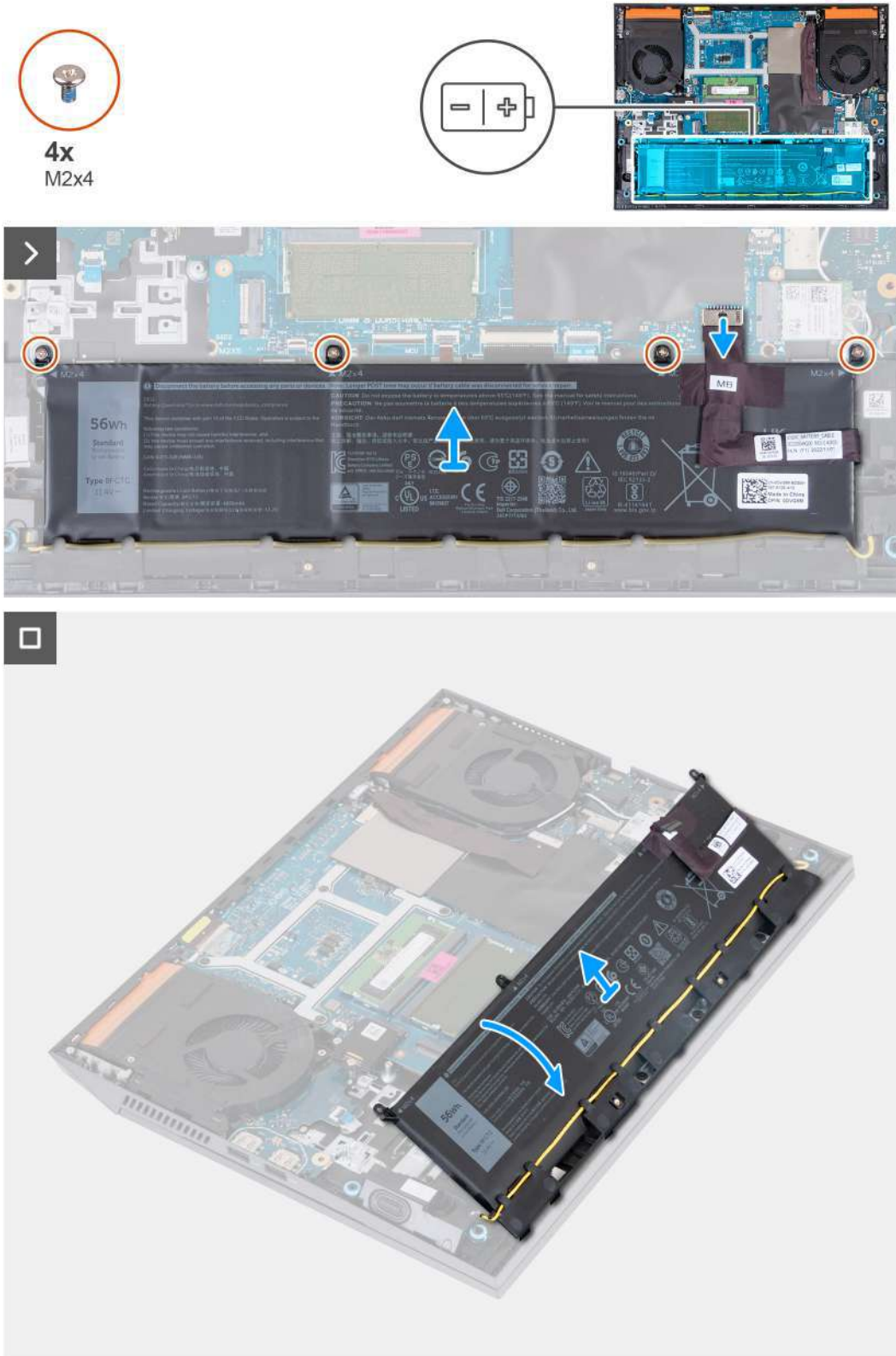

### Steps

1. Using the pull tab, disconnect the battery cable from the system board, if it is not previously disconnected.
2. Remove the four screws (M2x4) that secure the battery to the palm-rest and keyboard assembly.

3. Lift the battery at a 45 degree angle and remove it from the palm-rest and keyboard assembly.

## Installing the battery

### Prerequisites

If you are replacing a component, remove the existing component before performing the installation procedure.

### About this task

The following image indicates the location of the battery and provides a visual representation of the installation procedure.



4x  
M2x4

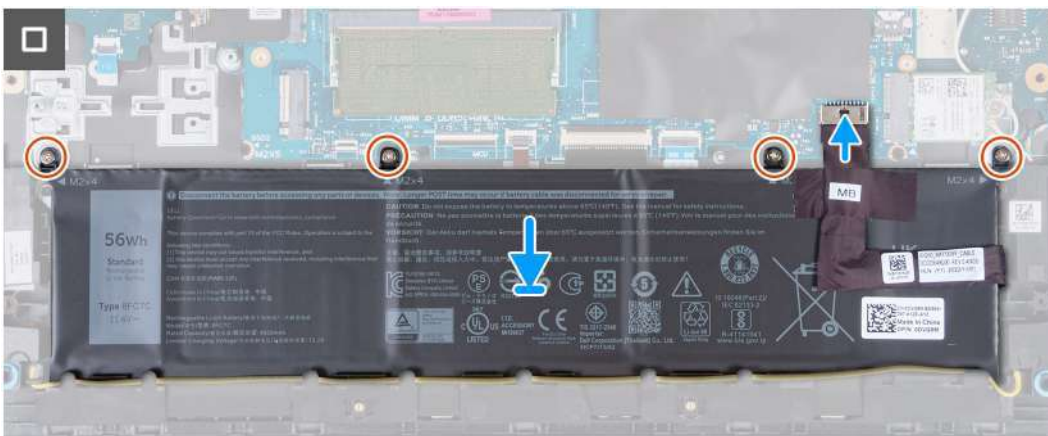
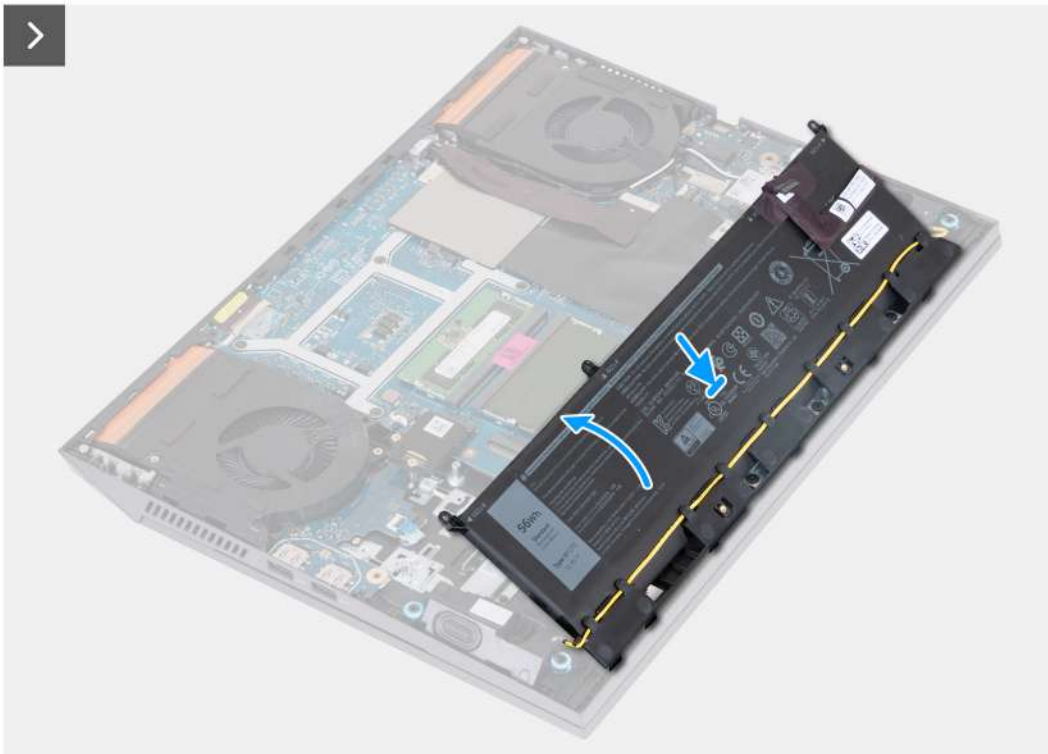
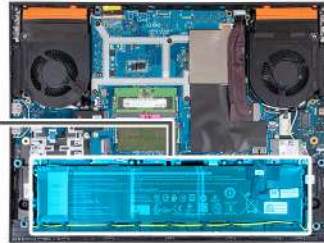
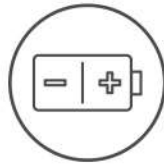

### Steps

1. At a 45 degree angle, slide the battery into the slot on the palm-rest and keyboard assembly.
2. Align the screw holes on the battery with the screw holes on the palm-rest and keyboard assembly.
3. Replace the four screws (M2x4) that secure the battery to the palm-rest and keyboard assembly.
4. Connect the battery cable to the system board.
5. Adhere the tape to secure the battery cable to the system board.

### Next steps

1. Install the [base cover](#).
2. Follow the procedure in [After working inside your computer](#).

## Touchpad

### Removing the touchpad

#### Prerequisites

1. Follow the procedure in [Before working inside your computer](#).
2. Remove the [base cover](#).
3. Remove the [battery](#).

#### About this task

The following image indicates the location of the touchpad and provides a visual representation of the removal procedure.





7x  
M2x2

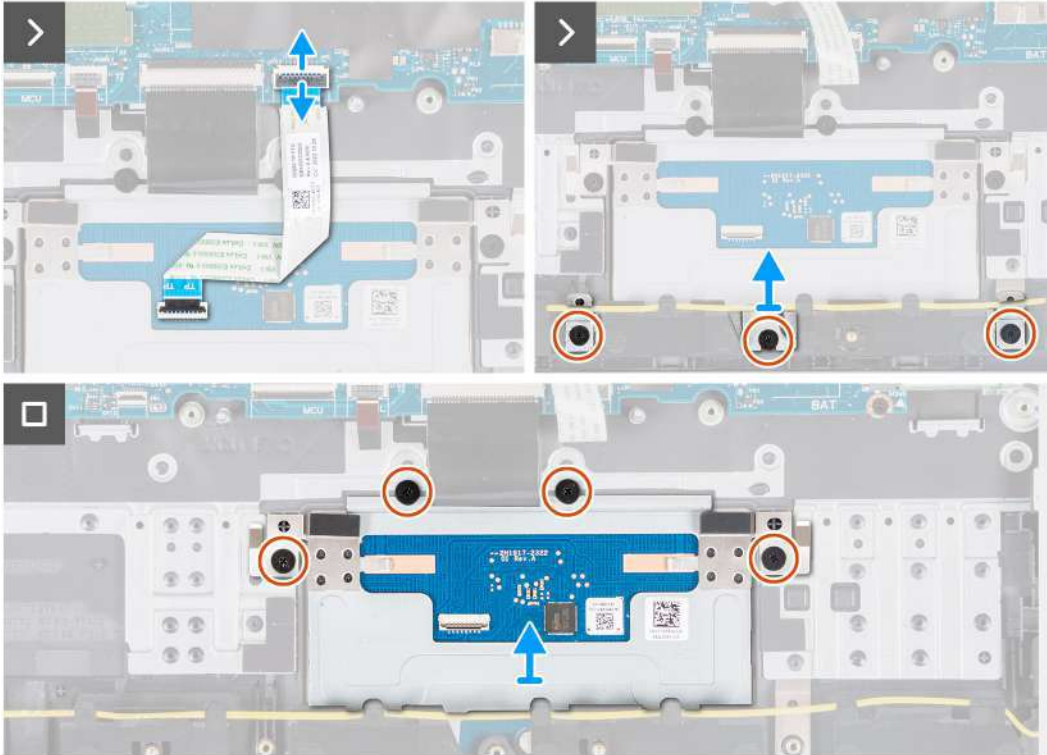

### Steps

1. Open the latch and disconnect the touchpad cable from the system board.
2. Remove the three (M2x2) screws that secure the touchpad bracket to the palm-rest and keyboard assembly.
3. Lift the touchpad bracket off the touchpad.
4. Remove the four (M2x2) screws that secure the touchpad to the palm-rest and keyboard assembly.
5. Lift the touchpad off the palm-rest and keyboard assembly.

## Installing the touchpad

### Prerequisites

If you are replacing a component, remove the existing component before performing the installation procedure.

### About this task

The following image indicates the location of the touchpad and provides a visual representation of the installation procedure.



7x  
M2x2

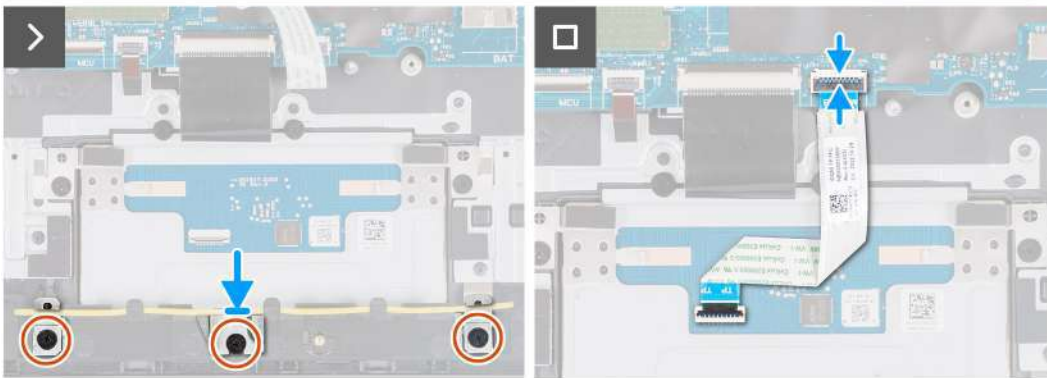
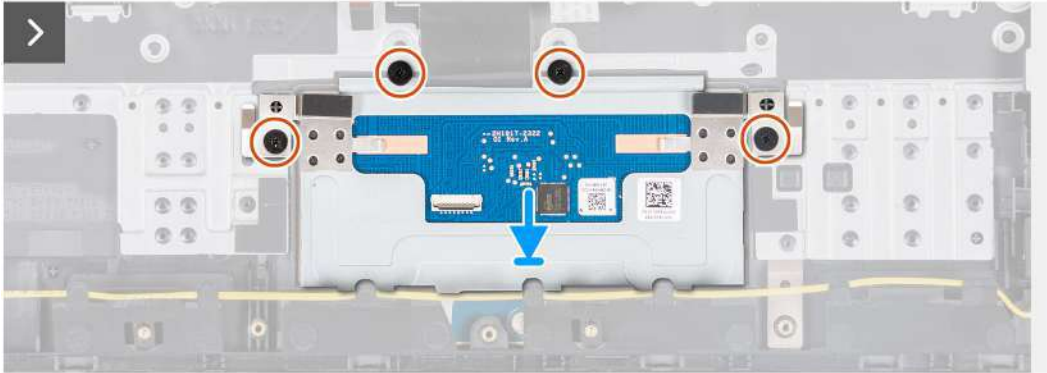

### Steps

1. Align and place the touchpad into the slot on the palm-rest and keyboard assembly.
2. Replace the four (M2x2) screws that secure the touchpad to the palm-rest and keyboard assembly.
3. Align and place the touchpad bracket into the slot on the palm-rest and keyboard assembly.
4. Replace the three (M2x2) screws that secure the touchpad bracket to the palm-rest and keyboard assembly.
5. Connect the touchpad cable to the system board and close the latch.

### Next steps

1. Install the [battery](#).
2. Install the [base cover](#).
3. Follow the procedure in [After working inside your computer](#).

## Display assembly

### Removing the display assembly

#### Prerequisites

1. Follow the procedure in [Before working inside your computer](#).
2. Remove the [base cover](#).
3. Remove the [rear cover](#).

**About this task**

The following images indicate the location of the display assembly and provide a visual representation of the removal procedure.





8x  
M2.5x4

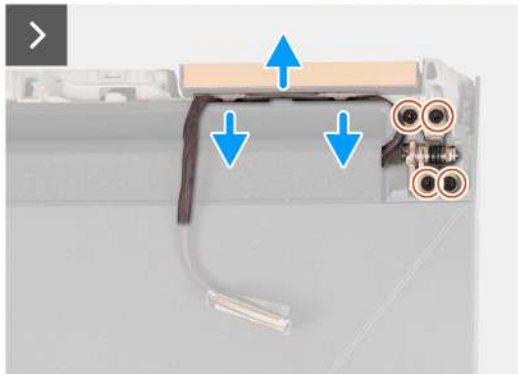
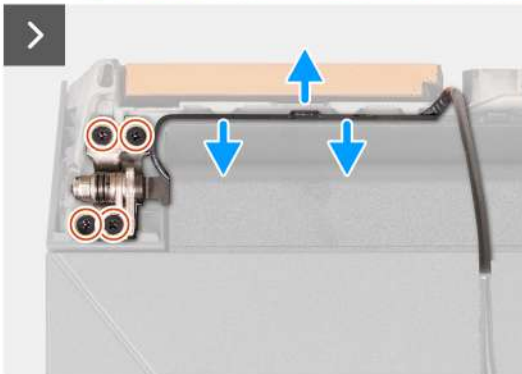
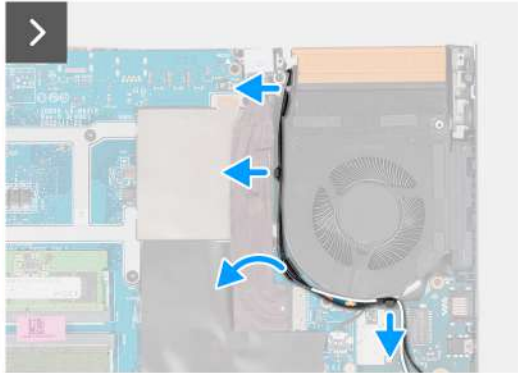
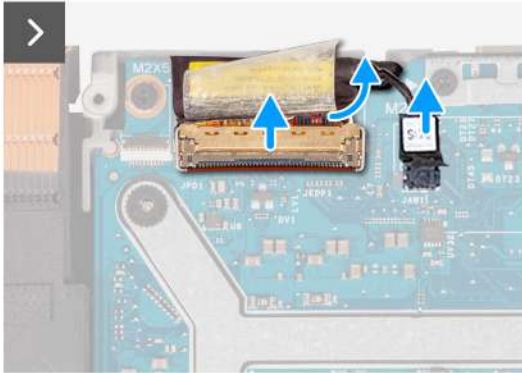
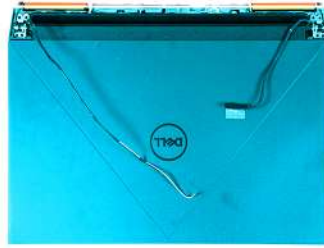

## Steps

1. Peel that tape that secures the display-cable latch to the system board.
2. Open the latch and disconnect the display cable from the system board.
3. Disconnect the dynamic-display switch (DDS) cable from the system board.

 **NOTE:** This step is applicable only for computers that are shipped with a 165 Hz or 240 Hz display.

4. Remove the antenna cables from the routing guides on the right fan.
5. Turn the computer over and place the computer on a clean and flat surface.
6. Remove the four screws (M2.5x4) that secure the left display-assembly hinge to the palm-rest and keyboard assembly.
7. Remove the antenna cables from the routing guides on the palm-rest and keyboard assembly, along the top side of the computer.
8. Remove the four screws (M2.5x4) that secure the right display-assembly hinge to the palm-rest and keyboard assembly.
9. Remove the display cable from the routing guides on the palm-rest and keyboard assembly, along the top side of the computer.
10. Gently lift the display assembly from the palm-rest and keyboard assembly.

## Installing the display assembly

### Prerequisites

If you are replacing a component, remove the existing component before performing the installation procedure.

### About this task

The following image indicates the location of the display assembly and provides a visual representation of the installation procedure.



8x  
M2.5x4

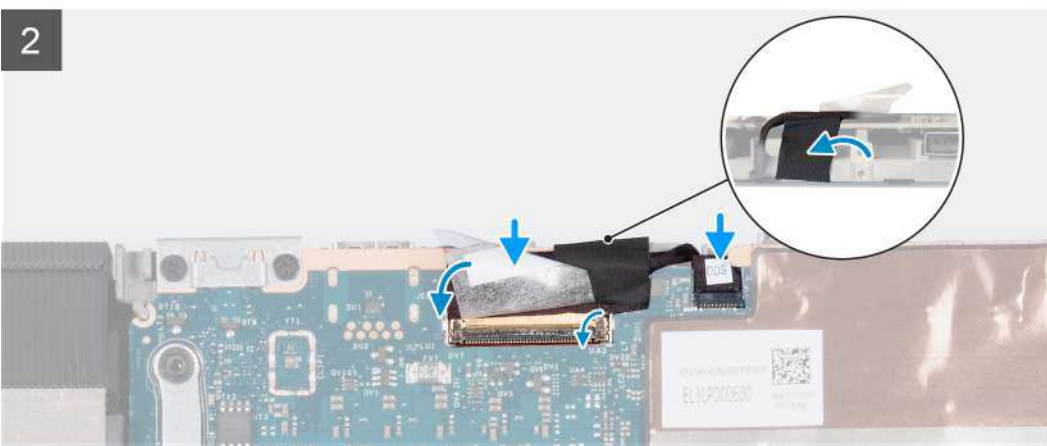
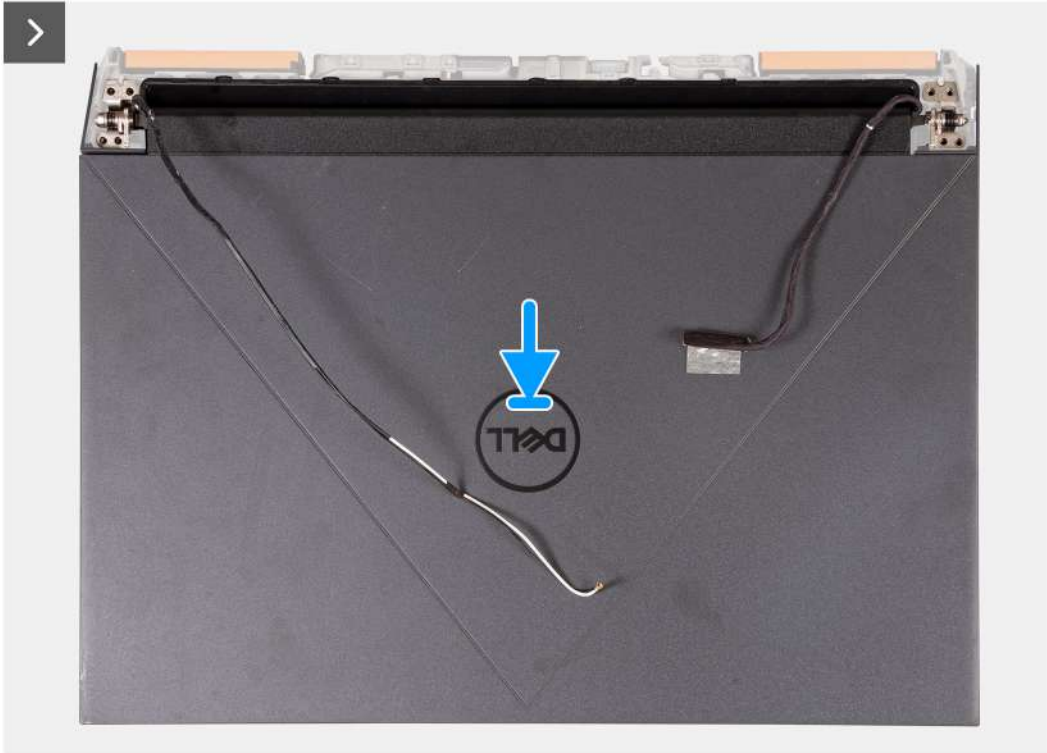

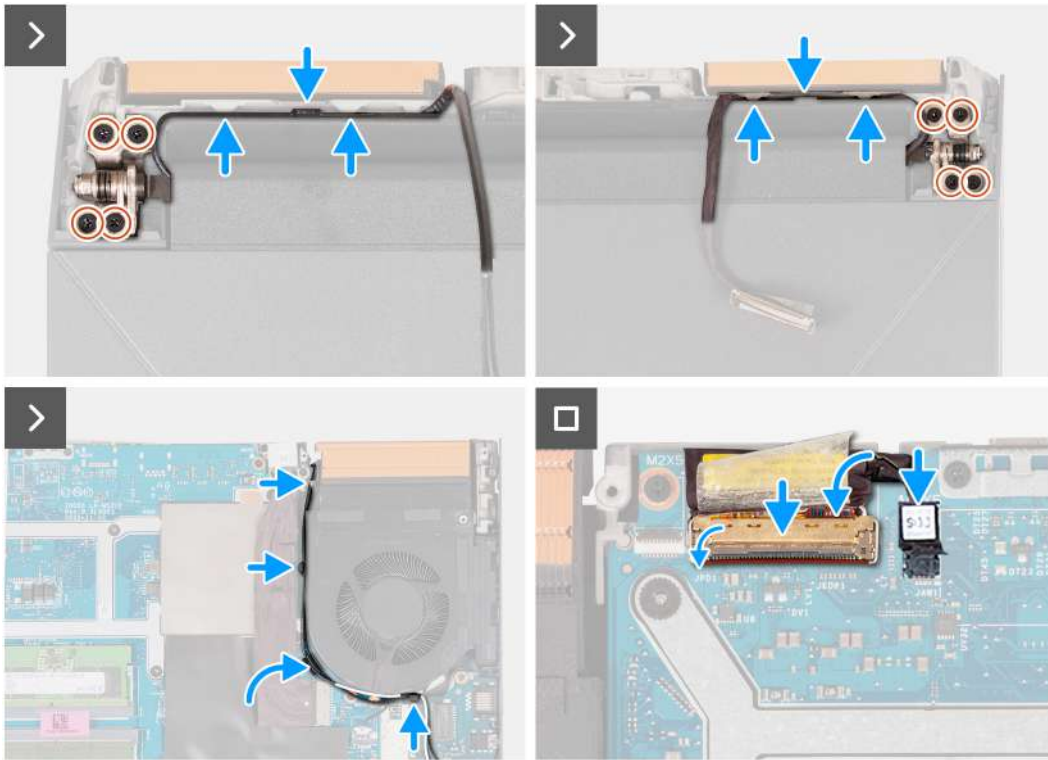

## Steps

1. Place the display assembly on the palm-rest and keyboard assembly.
2. Align the screw holes on the display hinges with screw holes on the palm-rest and keyboard assembly.
3. Replace the four screws (M2.5x4) that secure the left display-assembly hinge to the palm-rest and keyboard assembly.
4. Route the antenna cables through the routing guides on the palm-rest and keyboard assembly, along the top side of the computer, and into the opening to the right of the power-adaptor port.
5. Replace the four screws (M2.5x4) that secure the right display-assembly hinge to the palm-rest and keyboard assembly.
6. Route the display cable through the routing guides on the palm-rest and keyboard assembly, along the top side of the computer, and into the opening to left of the USB 3.2 Gen 2 (Type-C) port.
7. Turn the computer over and place the computer on a clean and flat surface.
8. Route the antenna cables through the routing guides on the fan.
9. Connect the display cable to the connector on the system board and close the latch.
10. Adhere the tape that secures the display-cable connector latch to the system board.
11. Connect the dynamic-display switch (DDS) cable to the system board.

**NOTE:** This step is applicable only for computers that are shipped with a 165 Hz or 240 Hz display.

## Next steps

1. Install the [rear cover](#).
2. Install the [base cover](#).
3. Follow the procedure in [After working inside your computer](#).

# Keyboard-controller board

## Removing the keyboard-controller board

### Prerequisites

1. Follow the procedure in [Before working inside your computer](#).
2. Remove the [base cover](#).
3. Remove the [battery](#).

### About this task

**NOTE:** The keyboard-controller board is only required for computers that are shipped with a 4-zone keyboard.



1x  
M2x2

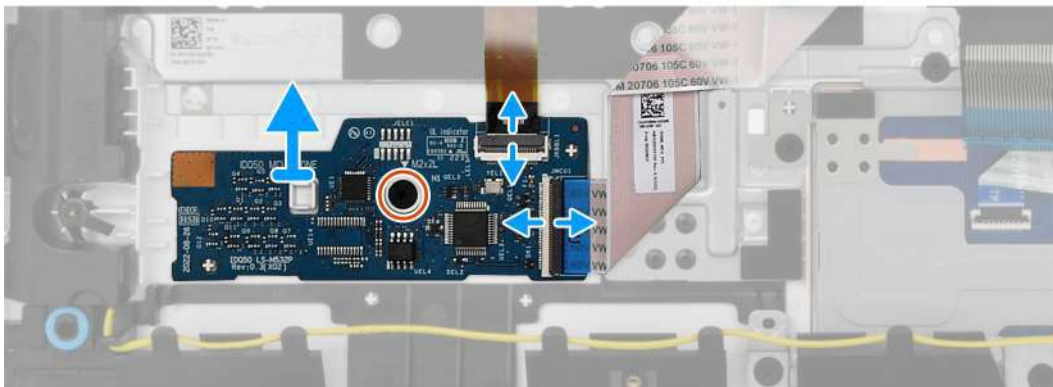

### Steps

1. Open the latch and disconnect the keyboard-backlight cable from the keyboard-controller board.
2. Open the latch and disconnect the keyboard-controller board cable from the keyboard-controller board.
3. Remove the screw (M2x2) that secures the keyboard-controller board to the palm-rest and keyboard assembly.
4. Lift the keyboard-controller board off the palm-rest and keyboard assembly.

## Installing the keyboard-controller board

### Prerequisites

If you are replacing a component, remove the existing component before performing the installation process.

### About this task

**NOTE:** The keyboard-controller board is only required for computers that are shipped with a 4-zone keyboard.





1x  
M2x2

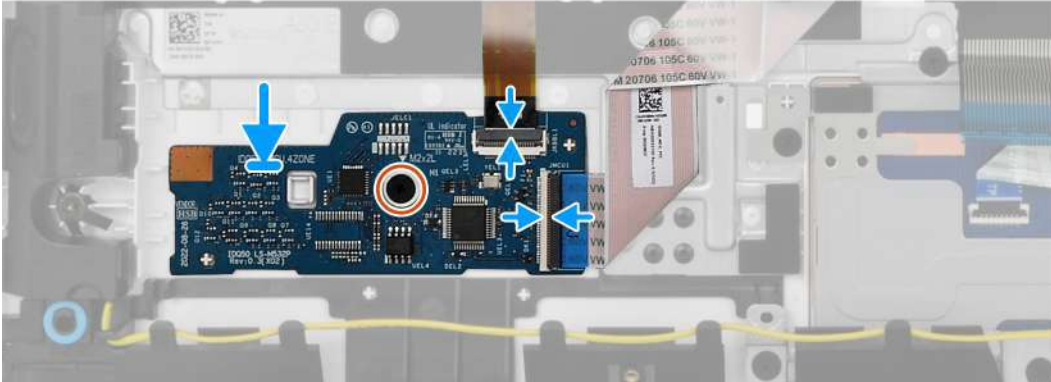

### Steps

1. Using the alignment posts, place the keyboard-controller board into the slot on the palm-rest and keyboard assembly.
2. Replace the screw (M2x2) that secures the keyboard-controller board to the palm-rest and keyboard assembly.
3. Connect the keyboard-controller board cable to the keyboard-controller board and close the latch.
4. Connect the keyboard-backlight cable to the keyboard-controller board and close the latch.

### Next steps

1. Install the [battery](#).
2. Install the [base cover](#).
3. Follow the procedure in [After working inside your computer](#).

## Power-adapter port

### Removing the power-adapter port

#### Prerequisites

1. Follow the procedure in [Before working inside your computer](#).
2. Remove the [base cover](#).
3. Remove the [rear cover](#).

#### About this task

The following image indicates the location of the power-adapter port and provides a visual representation of the removal procedure.



2x  
M2x5

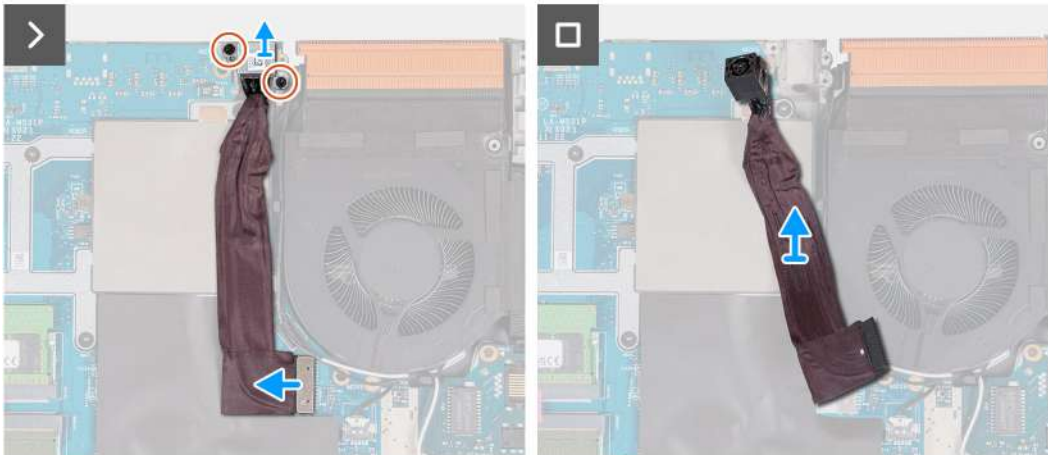
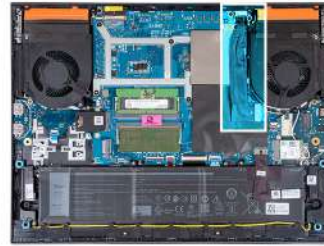

### Steps

1. Remove the two screws (M2x5) that secure the power-adapter port bracket to the palm-rest and keyboard assembly.
2. Lift the power-adapter port-bracket off the power-adapter port.
3. Peel the power-adapter port cable off the system board.
4. Disconnect the power-adapter port-cable from the system board.
5. Lift the power-adapter port and its cable off the palm-rest and keyboard assembly.

## Installing the power-adapter port

### Prerequisites

If you are replacing a component, remove the existing component before performing the installation procedure.

### About this task

The following image indicates the location of the power-adapter port and provides a visual representation of the installation procedure.



2x  
M2x5

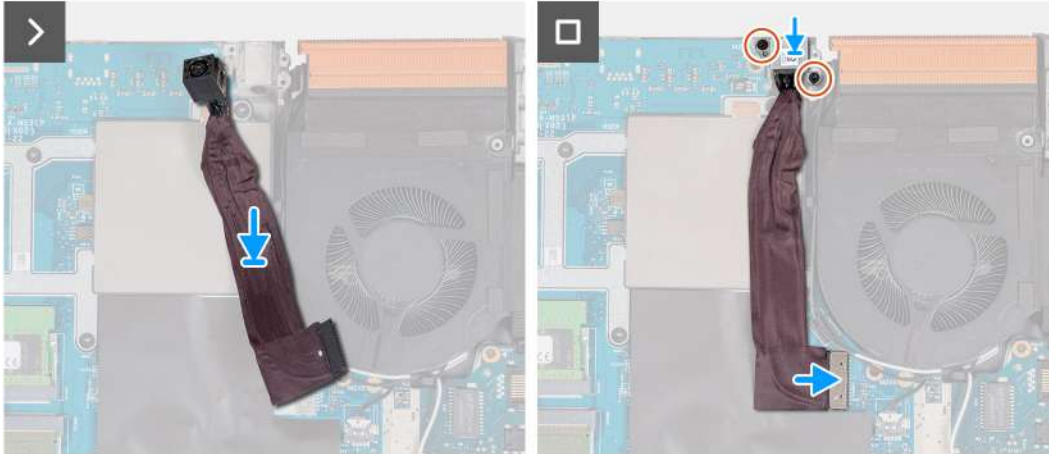
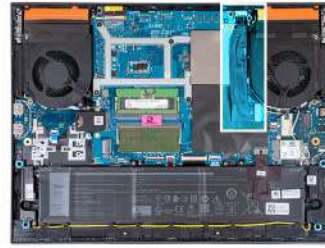

### Steps

1. Place the power-adapter port into the slot and adhere the power-adapter port cable on the system board.
2. Connect the power-adapter port cable to the system board.
3. Place the power-adapter port bracket on the power-adapter port and align the screw holes on the power-adapter port bracket to the screw holes on the palm-rest and keyboard assembly.
4. Replace the two screws (M2x5) that secure the power-adapter port bracket to the palm-rest and keyboard assembly.

### Next steps

1. Install the [rear cover](#).
2. Install the [base cover](#).
3. Follow the procedure in [After working inside your computer](#).

## System board

### Removing the system board (Single-color keyboard)

 **NOTE:** This procedure is applicable only for computers that are shipped with a single-color keyboard.

### Prerequisites

1. Follow the procedure in [Before working inside your computer](#).
2. Remove the [base cover](#).
3. Remove the [battery](#).
4. Remove the [rear cover](#).
5. Remove the [solid-state drive](#).
6. Remove the [wireless card](#).
7. Remove the [memory module](#).



**About this task**

**CAUTION:** Before removing the system board, give sufficient time for the heat sink to cool down to avoid injury.

**NOTE:** Replacing the system board removes any changes that you have made to the BIOS using the BIOS setup program. Make the appropriate changes again after you replace the system board.

The following image indicates the connectors on your system-board assembly.

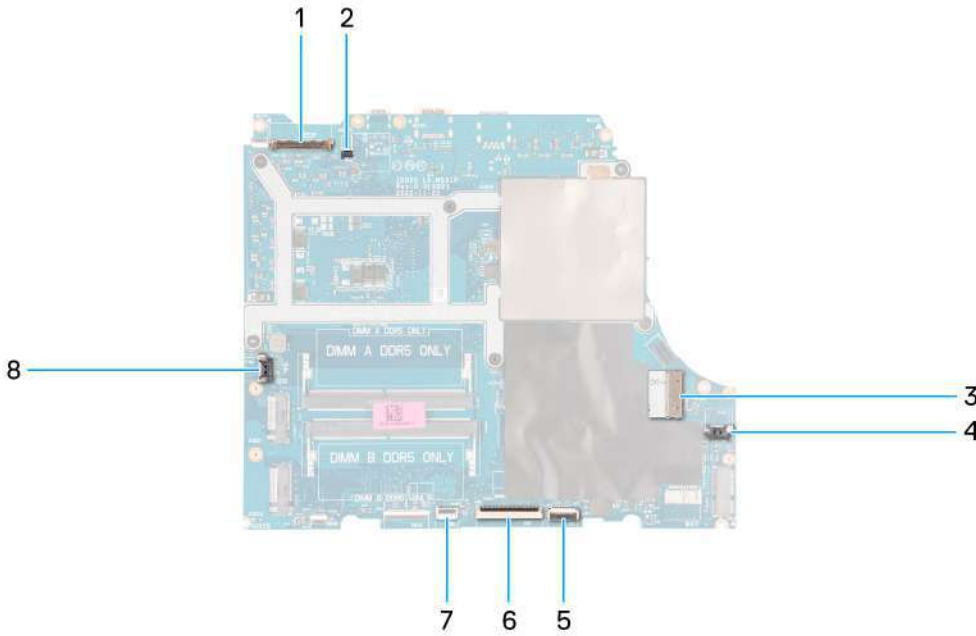

- 1. Display cable
- 2. Dynamic-display switch (DDS) cable (applicable to computers with a 165 Hz or 240 Hz display)
- 3. Power-adaptor port cable
- 4. Right-fan cable
- 5. Touchpad cable
- 6. Keyboard cable
- 7. Keyboard-backlight cable
- 8. Left-fan cable

The following image indicates the location of the system board and provides a visual representation of the removal procedure.

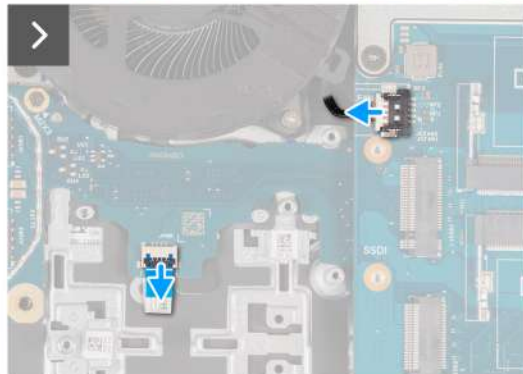
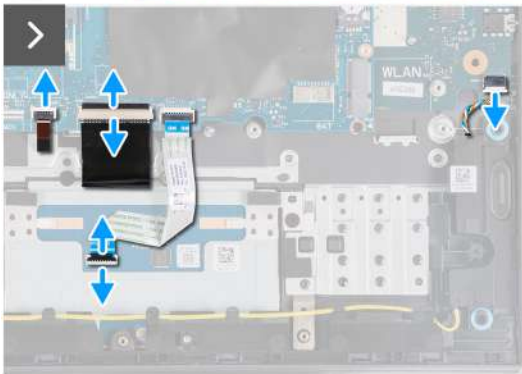
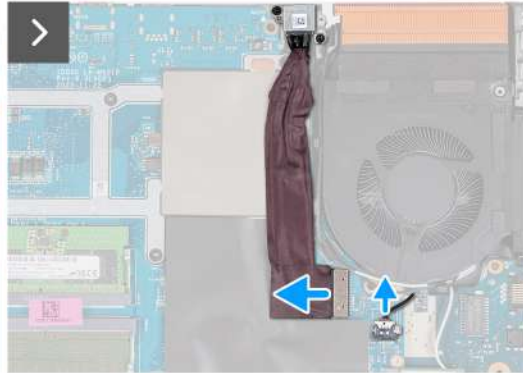
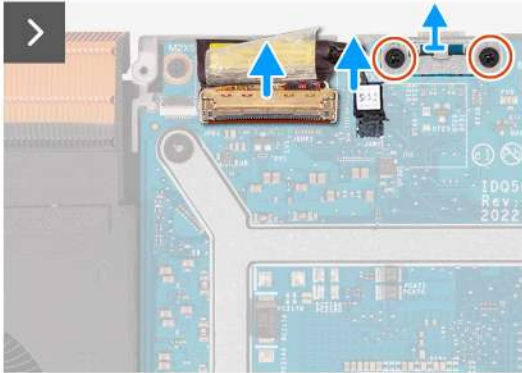
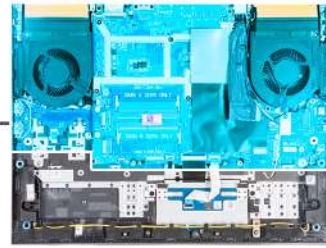

**Steps**

1. Peel the tape that secures the display-cable connector latch to the system board.
2. Open the latch and disconnect the display cable from the system board.
3. Disconnect the dynamic-display switch (DDS) cable from the system board.

**NOTE:** This step is applicable only for computers that are shipped with a 165 Hz or 240 Hz display.

4. Remove the two (M2x5) screws that secure the Type-C bracket to the system board and lift the bracket off the system board.
5. Disconnect the power-adaptor port cable from the system board.
6. Peel the power-adaptor port cable off the system board.
7. Disconnect the right-fan cable from the system board.
8. Disconnect the speaker cable from the system board.
9. Open the latch and disconnect the touchpad cable from the system board.
10. Open the latch and disconnect the keyboard cable from the system board.
11. Open the latch and disconnect the keyboard-backlight cable from the system board.
12. Disconnect the left-fan cable from the system board.
13. Remove the five screws (M2x5) that secure the system board to the palm-rest and keyboard assembly.
14. Remove the screw (M2x3) that secures the USB board to the palm-rest and keyboard assembly.
15. Remove the screw (M2x3) that secures the ethernet and audio board to the palm-rest and keyboard assembly.
16. Remove the screw (M2x4) that secures the left fan to the palm-rest and keyboard assembly.
17. Lift the system-board assembly off the palm-rest and keyboard assembly.

**NOTE:** Ensure that you lift the system board from the top left and right sides of the heat sink.

18. Place the system-board assembly on a clean and flat surface.
19. Turn the system-board assembly over and remove the [ethernet and audio board](#), [USB board](#), and [fan and heat-sink assembly](#).

## Installing the system board (Single-color keyboard)

**NOTE:** This procedure is applicable only for computers that are shipped with a single-color keyboard.

### Prerequisites

If you are replacing a component, remove the existing component before performing the installation procedure.

**NOTE:** Replacing the system board removes any changes that you have made to the BIOS using the BIOS setup program. Make the appropriate changes again after you replace the system board.

### About this task

The following image indicates the connectors on your system board.

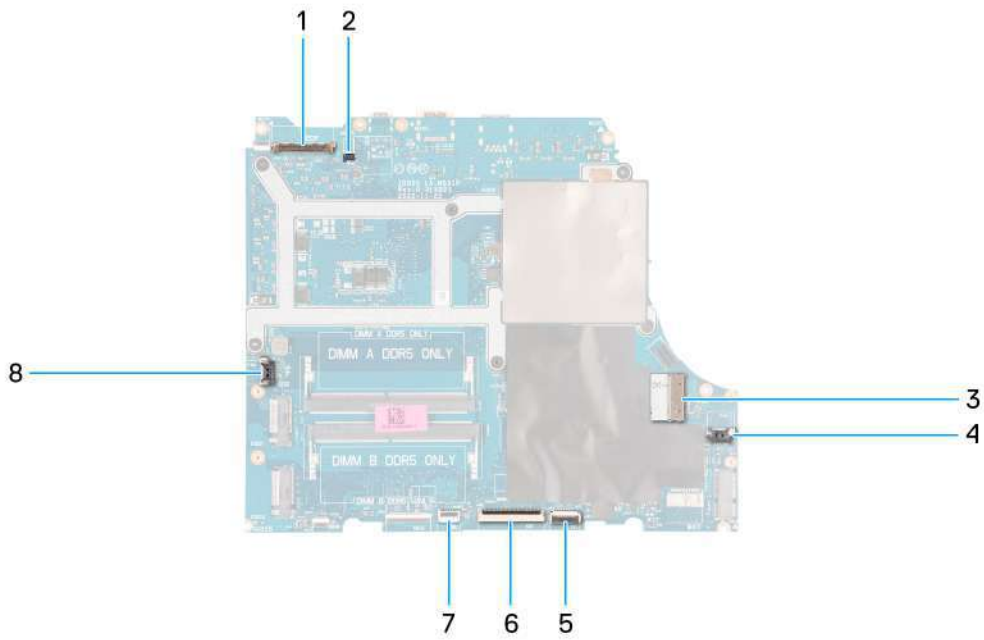

1. Display cable
2. Dynamic-display switch (DDS) cable
3. Power-adapter port cable
4. Right-fan cable
5. Touchpad cable
6. Keyboard cable
7. Keyboard-backlight cable
8. Left-fan cable

The following image indicates the location of the system board and provides a visual representation of the installation procedure.



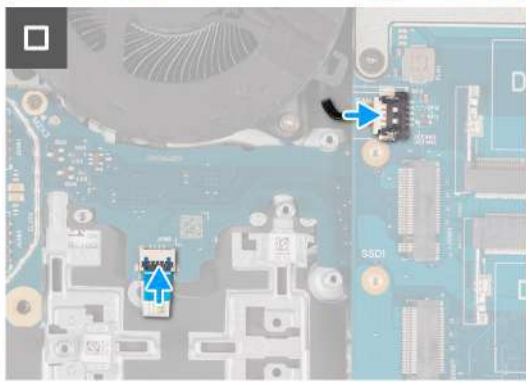
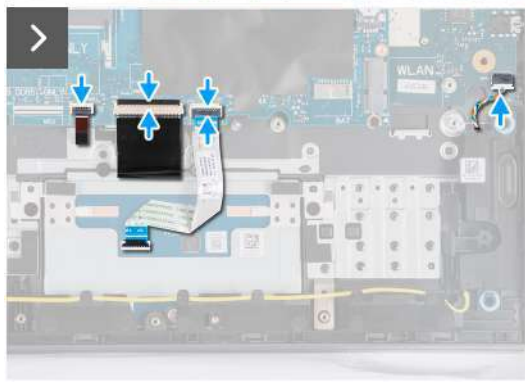
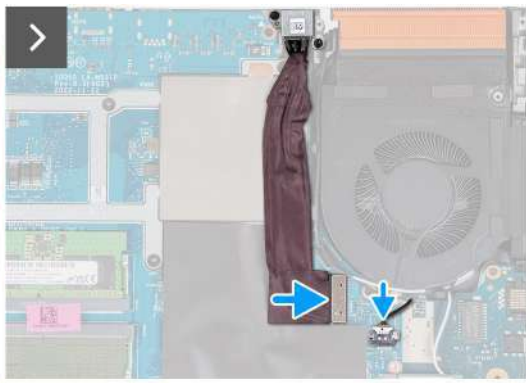
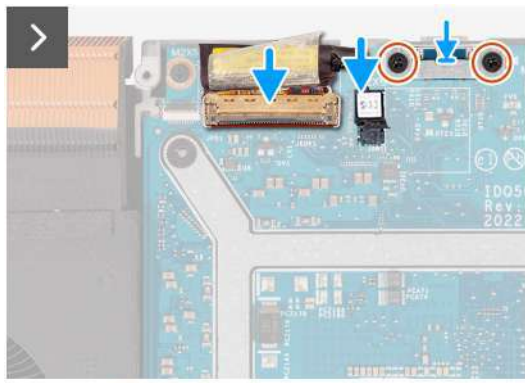
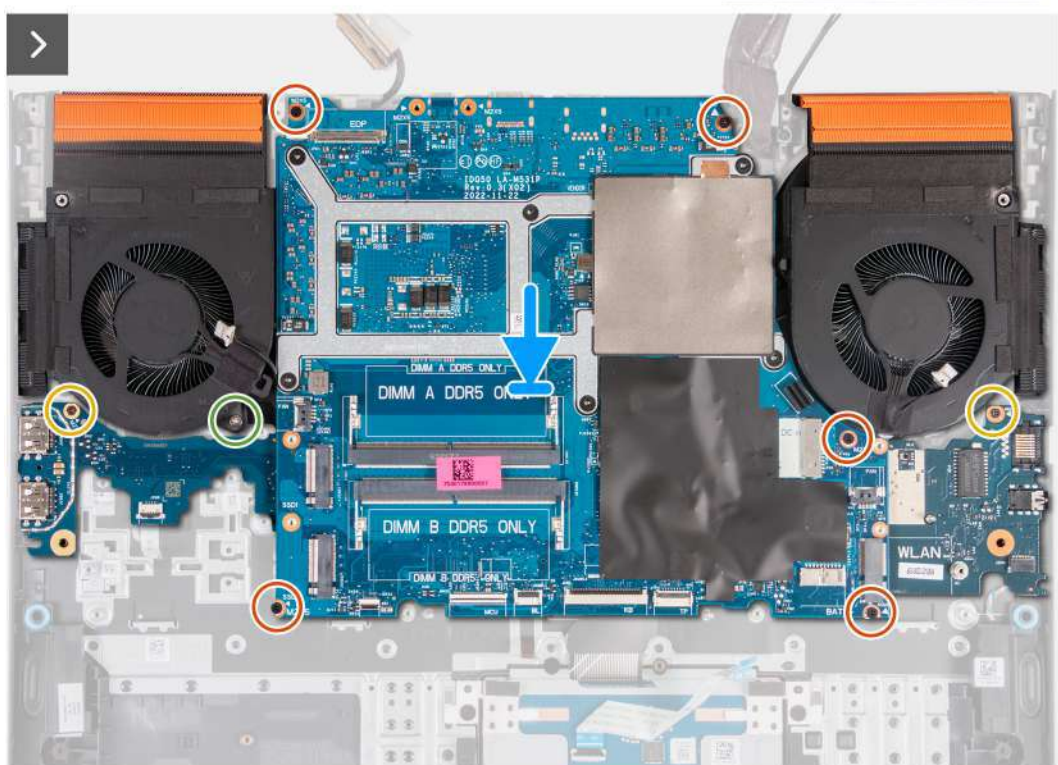
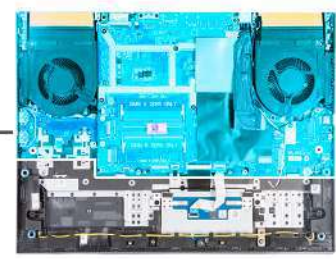
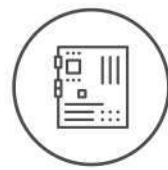

## Steps

1. Place the system board on a clean and flat surface.
2. Install the [ethernet and audio board](#), [USB board](#), and [fan and heat-sink assembly](#).
3. Turn the system board over.
4. Using the alignment posts, place the system board on the palm-rest and keyboard assembly, ensuring that the heat sink is aligned against the top edge of the palm-rest and keyboard assembly.
5. Align the screw holes on the system board with the screw holes on the palm-rest and keyboard assembly.
6. Replace the five screws (M2x5) that secure the system board to the palm-rest and keyboard assembly.
7. Replace the screw (M2x3) that secures the USB board to the palm-rest and keyboard assembly.
8. Replace the screw (M2x3) that secures the ethernet and audio board to the palm-rest and keyboard assembly.
9. Replace the screw (M2x4) that secures the left fan to the palm-rest and keyboard assembly.
10. Align the screw holes on the Type-C bracket with the screw holes on the system board.
11. Replace the two screws (M2x5) that secure the Type-C bracket to the system board.
12. Connect the DDS (Dynamic Display Switch) cable to the system board.

 **NOTE:** This step is applicable only for computers that are shipped with a 165 Hz or 240 Hz display.

13. Connect the display cable to the system board and close the latch.
14. Adhere the tape that secures the display-cable connector latch to the system board.
15. Connect the power-adaptor port cable to the system board.
16. Adhere the power-adaptor port cable on the system board.
17. Connect the right-fan cable to the system board.
18. Connect the speaker cable to the system board.
19. Connect the touchpad cable to the system board and close the latch.
20. Connect the keyboard cable to the system board and close the latch.
21. Connect the keyboard-backlight cable to the system board and close the latch.
22. Connect the left-fan cable to the system board.

## Next steps

1. Install the [memory module](#).
2. Install the [wireless card](#).
3. Install the [solid-state drive](#).
4. Install the [rear cover](#).
5. Install the [battery](#).
6. Install the [base cover](#).
7. Follow the procedure in [After working inside your computer](#).

## Removing the system board (Four-zone keyboard)

 **NOTE:** This procedure is applicable only for computers that are shipped with a four-zone keyboard.

## Prerequisites

1. Follow the procedure in [Before working inside your computer](#).
2. Remove the [base cover](#).
3. Remove the [battery](#).
4. Remove the [rear cover](#).
5. Remove the [solid-state drive](#).
6. Remove the [wireless card](#).
7. Remove the [memory module](#).

**About this task**

**CAUTION:** Before removing the system board, give sufficient time for the heat sink to cool down to avoid injury.

**NOTE:** Replacing the system board removes any changes that you have made to the BIOS using the BIOS setup program. Make the appropriate changes again after you replace the system board.

The following image indicates the connectors on your system-board assembly.

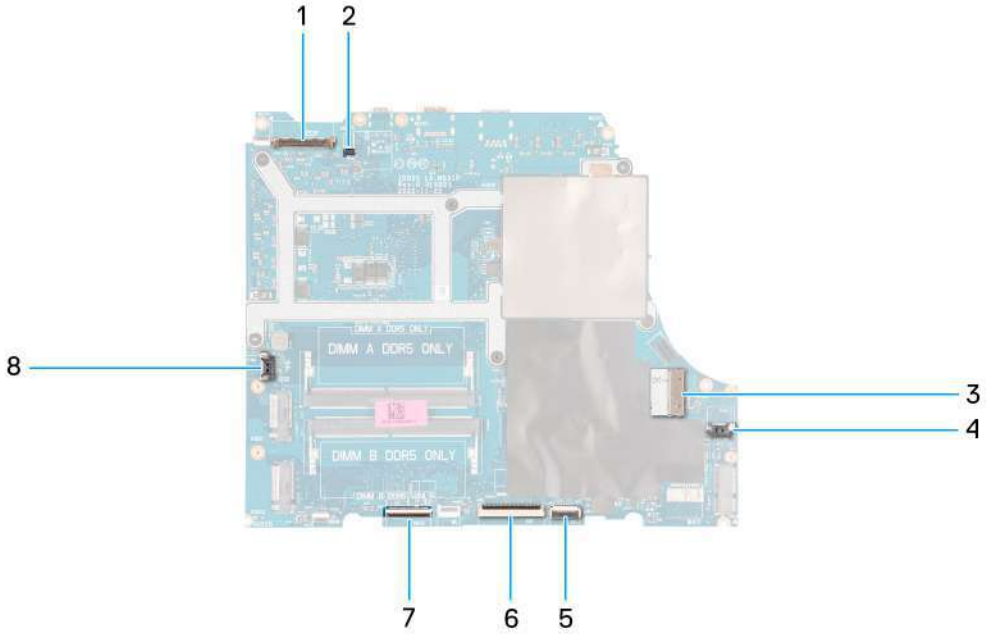

- 1. Display cable
- 2. Dynamic-display switch (DDS) cable
- 3. Power-adaptor port cable
- 4. Right-fan cable
- 5. Touchpad cable
- 6. Keyboard cable
- 7. Keyboard-controller board cable
- 8. Left-fan cable

The following image indicates the location of the system board and provides a visual representation of the removal procedure.



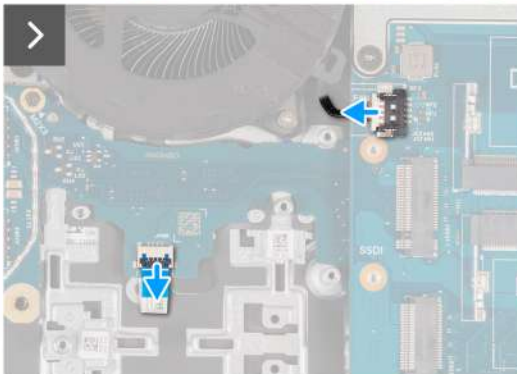
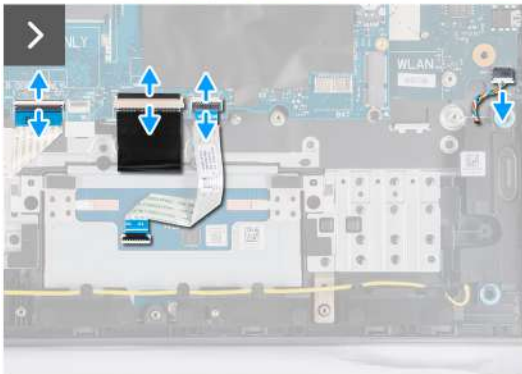
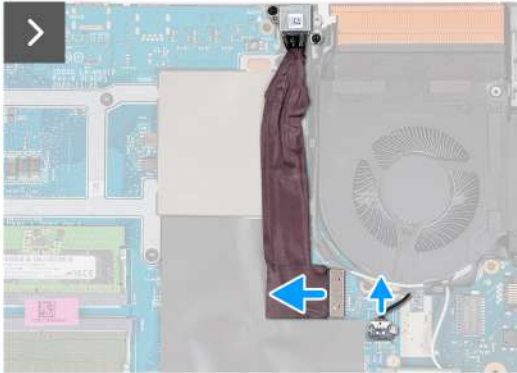
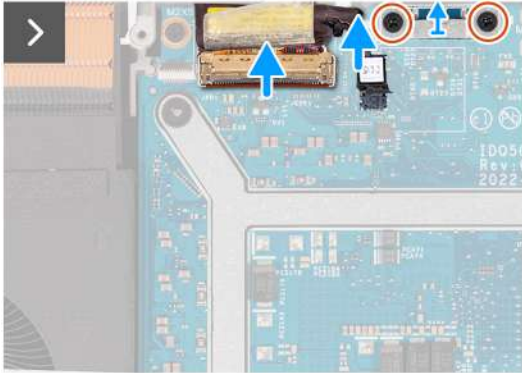
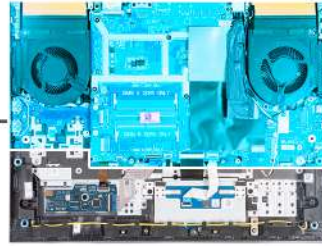

**Steps**

1. Peel the tape that secures the display-cable connector latch to the system board.
2. Open the latch and disconnect the display cable from the system board.
3. Disconnect the dynamic-display switch (DDS) cable from the system board.



**NOTE:** This step is applicable only for computers that are shipped with a 165 Hz or 240 Hz display.

4. Remove the two (M2x5) screws that secure the Type-C bracket to the system board and lift the bracket off the system board.
5. Disconnect the power-adaptor port cable from the system board.
6. Peel the power-adaptor port cable off the system board.
7. Disconnect the right-fan cable from the system board.
8. Disconnect the speaker cable from the system board.
9. Open the latch and disconnect the touchpad cable from the system board.
10. Open the latch and disconnect the keyboard cable from the system board.
11. Open the latch and disconnect the keyboard-controller board cable from the system board.
12. Disconnect the left-fan cable from the system board.
13. Open the latch and disconnect the power-button cable from the USB board.
14. Remove the five screws (M2x5) that secure the system board to the palm-rest and keyboard assembly.
15. Remove the screw (M2x3) that secures the USB board to the palm-rest and keyboard assembly.
16. Remove the screw (M2x3) that secures the ethernet and audio board to the palm-rest and keyboard assembly.
17. Remove the screw (M2x4) that secures the left fan to the palm-rest and keyboard assembly.
18. Lift the system-board assembly off the palm-rest and keyboard assembly.

**NOTE:** Ensure that you lift the system board from the top left and right sides of the heat sink.

19. Place the system-board assembly on a clean and flat surface.
20. Turn the system-board assembly over and remove the [ethernet and audio board](#), [USB board](#), and [fan and heat-sink assembly](#).

## Installing the system board (Four-zone keyboard)

**NOTE:** This procedure is applicable only for computers that are shipped with a four-zone keyboard.

### Prerequisites

If you are replacing a component, remove the existing component before performing the installation procedure.

**NOTE:** Replacing the system board removes any changes that you have made to the BIOS using the BIOS setup program. Make the appropriate changes again after you replace the system board.

### About this task

The following image indicates the connectors on your system board.

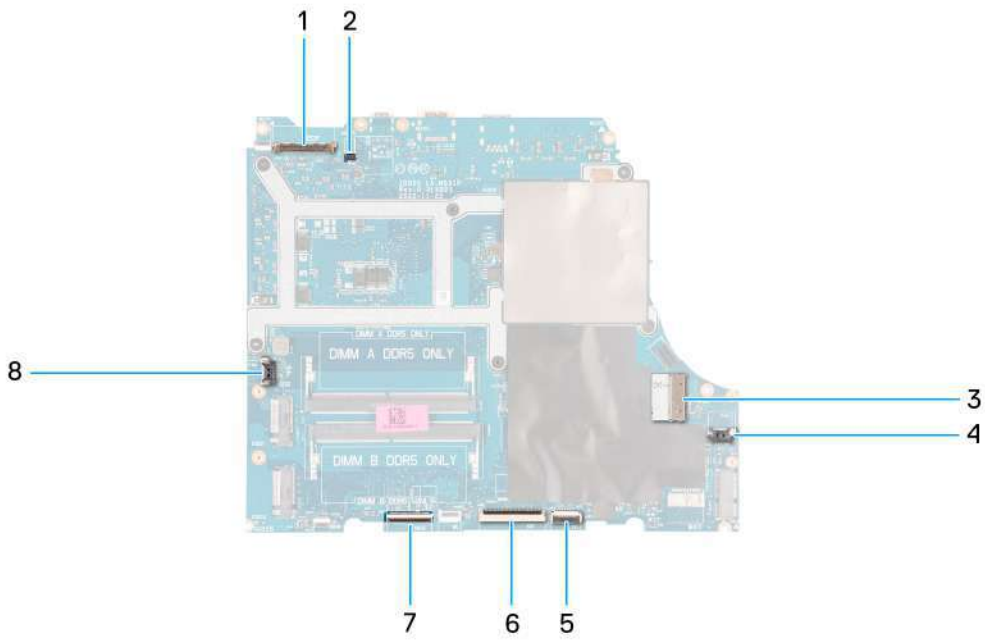

1. Display cable
2. Dynamic-display switch (DDS) cable
3. Power-adapter port cable
4. Right-fan cable
5. Touchpad cable
6. Keyboard cable
7. Keyboard-controller board cable
8. Power-button cable
9. Left-fan cable

The following image indicates the location of the system board and provides a visual representation of the installation procedure.

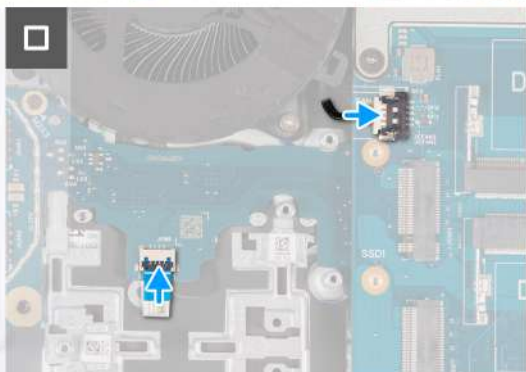
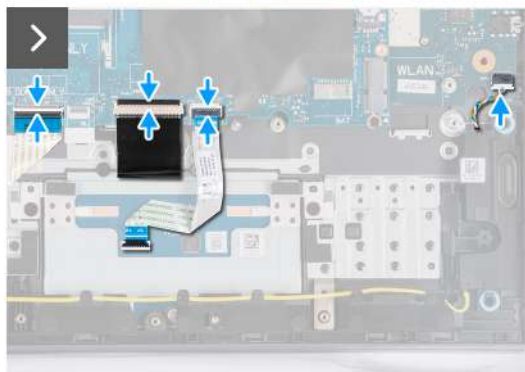
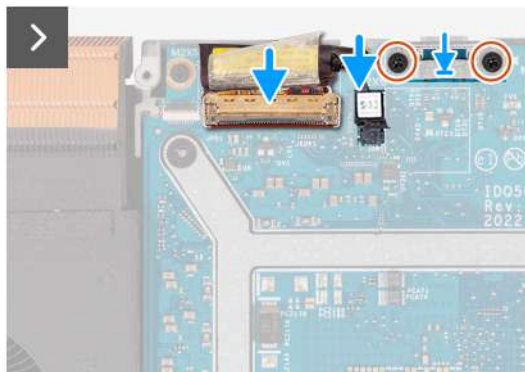
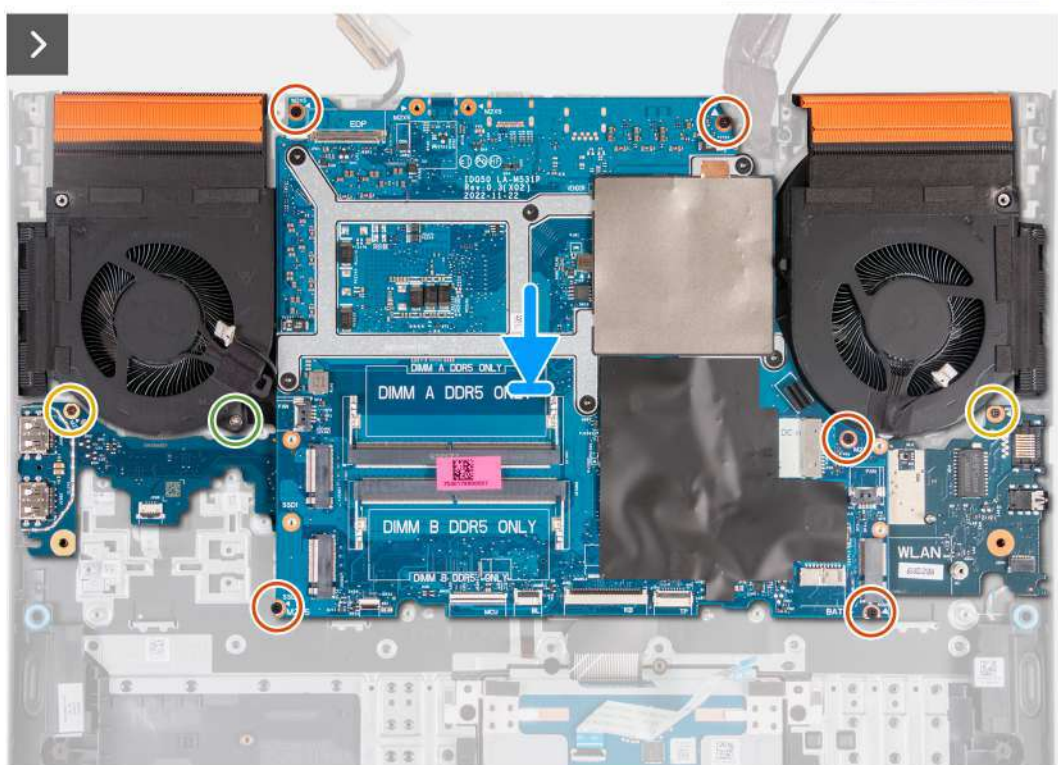
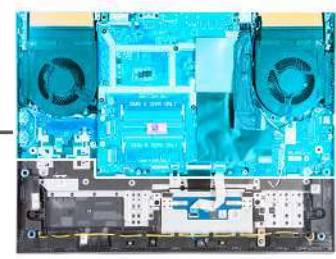
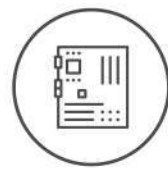

## Steps

1. Place the system board on a clean and flat surface.
2. Install the [ethernet and audio board](#), [USB board](#), and [fan and heat-sink assembly](#).
3. Turn the system board over.
4. Using the alignment posts, place the system board on the palm-rest and keyboard assembly, ensuring that the heat sink is aligned against the top edge of the palm-rest and keyboard assembly.
5. Align the screw holes on the system board with the screw holes on the palm-rest and keyboard assembly.
6. Replace the five screws (M2x5) that secure the system board to the palm-rest and keyboard assembly.
7. Replace the screw (M2x3) that secures the USB board to the palm-rest and keyboard assembly.
8. Replace the screw (M2x3) that secures the ethernet and audio board to the palm-rest and keyboard assembly.
9. Replace the screw (M2x4) that secures the left fan to the palm-rest and keyboard assembly.
10. Align the screw holes on the Type-C bracket with the screw holes on the system board.
11. Replace the two screws (M2x5) that secure the Type-C bracket to the system board.
12. Connect the DDS (Dynamic Display Switch) cable to the system board.

 **NOTE:** This step is applicable only for computers that are shipped with a 165 Hz or 240 Hz display.

13. Connect the display cable to the system board and close the latch.
14. Adhere the tape that secures the display-cable connector latch to the system board.
15. Connect the power-adaptor port cable to the system board.
16. Adhere the power-adaptor port cable on the system board.
17. Connect the right-fan cable to the system board.
18. Connect the speaker cable to the system board.
19. Connect the touchpad cable to the system board and close the latch.
20. Connect the keyboard cable to the system board and close the latch.
21. Connect the keyboard-controller board cable to the system board and close the latch.
22. Connect the power-button cable to the USB board and close the latch.
23. Connect the left-fan cable to the system board.

## Next steps

1. Install the [memory module](#).
2. Install the [wireless card](#).
3. Install the [solid-state drive](#).
4. Install the [rear cover](#).
5. Install the [battery](#).
6. Install the [base cover](#).
7. Follow the procedure in [After working inside your computer](#).

# USB board

## Removing the USB board

### Prerequisites

1. Follow the procedure in [Before working inside your computer](#).
2. Remove the [base cover](#).
3. Remove the [battery](#).
4. Remove the [rear cover](#).
5. Remove the [solid-state drive](#).
6. Remove the [wireless card](#).
7. Remove the [memory module](#).
8. Remove the [system board](#).

**NOTE:** The system board can be removed as an assembly with the fan and heat-sink assembly, ethernet and audio board, and USB board attached.

### About this task

The following image indicates the location of the USB board and provides a visual representation of the removal procedure.

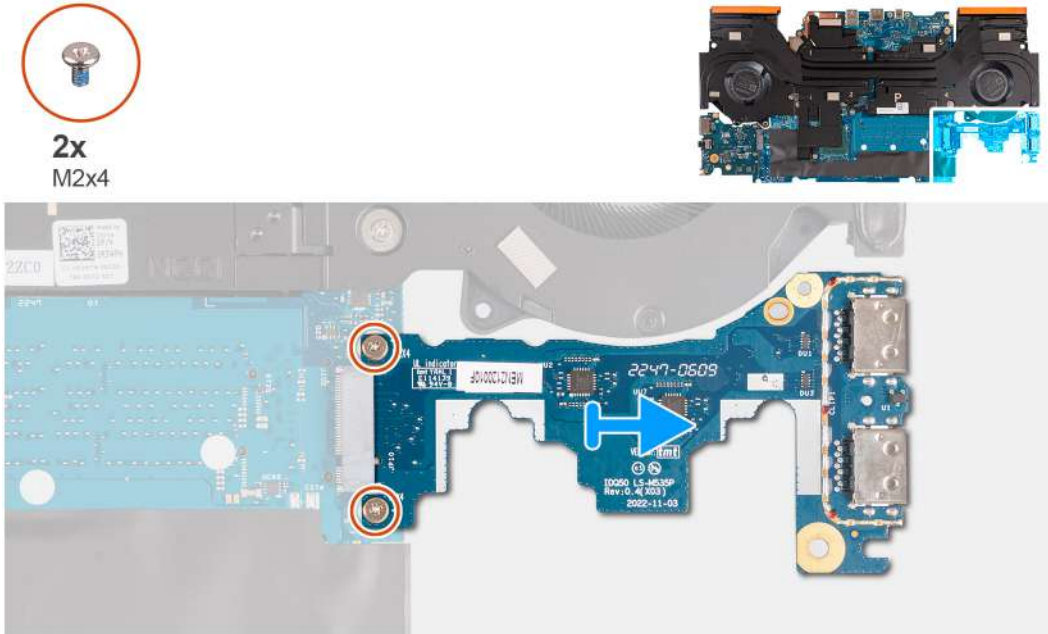

### Steps

1. Turn the system-board assembly over.
2. Remove the two screws (M2x4) that secure the USB board to the system-board assembly.
3. Disconnect and remove USB board from the system-board assembly.

## Installing the USB board

### Prerequisites

If you are replacing a component, remove the existing component before performing the installation procedure.

### About this task

The following image indicates the location of the USB board and provides a visual representation of the installation procedure.





**2x**  
M2x4

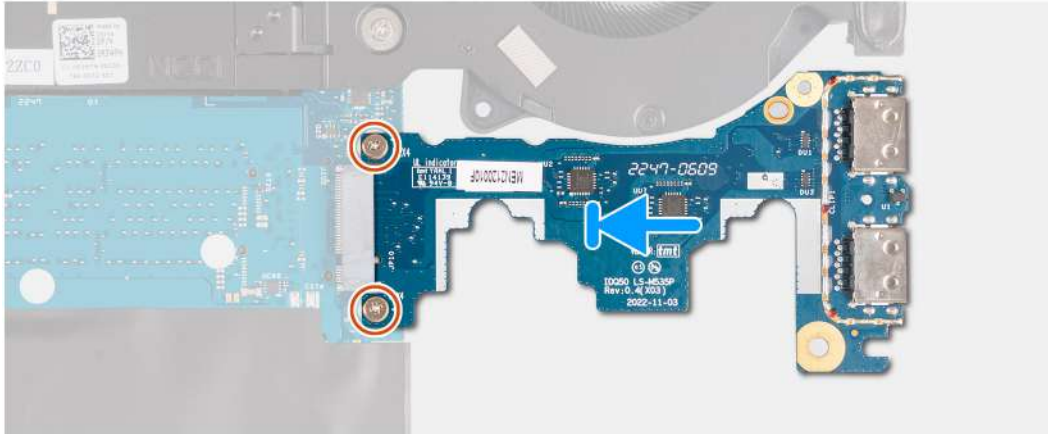

### Steps

1. Slide the USB board into the M.2 card slot on the system board and align the screw holes on the USB board to the screw holes on the system board.
2. Replace the two screws (M2x4) that secure the USB board to the system board.
3. Turn the system-board assembly over.

### Next steps

1. Install the [system board](#).
2. Install the [memory module](#).
3. Install the [wireless card](#).
4. Install the [solid-state drive](#).
5. Install the [rear cover](#).
6. Install the [battery](#).
7. Install the [base cover](#).
8. Follow the procedure in [After working inside your computer](#).

## Ethernet and audio board

### Removing the ethernet and audio board

#### Prerequisites

#### About this task

The following image indicates the location of the ethernet and audio board and provides a visual representation of the removal procedure.

1. Follow the procedure in [Before working inside your computer](#).
2. Remove the [base cover](#).
3. Remove the [battery](#).
4. Remove the [rear cover](#).

5. Remove the [solid-state drive](#).
6. Remove the [wireless card](#).
7. Remove the [memory module](#).
8. Remove the [system board](#).

**NOTE:** The system board can be removed as an assembly with the fan and heat-sink assembly, ethernet and audio board, and USB board attached.



**2x**  
M2x4

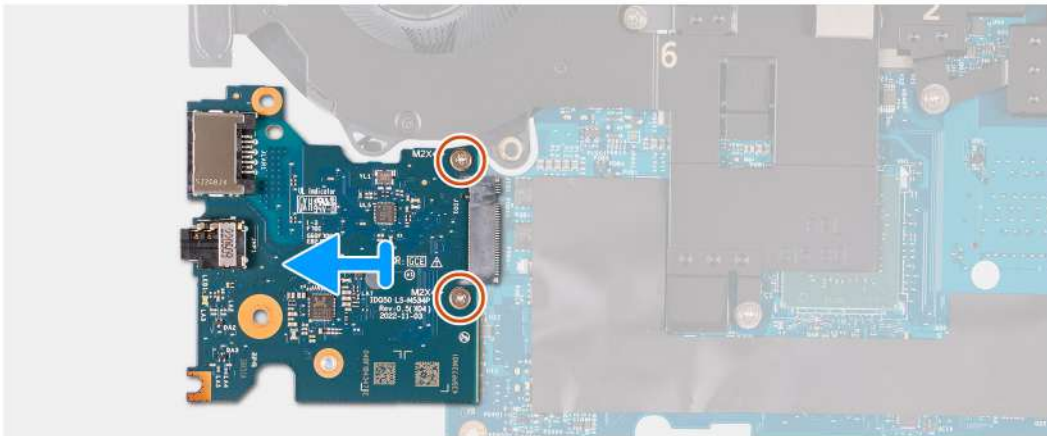

### Steps

1. Turn the system-board assembly over.
2. Remove the two screws (M2x4) that secure the ethernet and audio board to the system board.
3. Disconnect and remove the ethernet and audio board from the system board.

## Installing the ethernet and audio board

### Prerequisites

If you are replacing a component, remove the existing component before performing the installation procedure.

### About this task

The following image indicates the location of the ethernet and audio board and provides a visual representation of the installation procedure.





2x  
M2x4

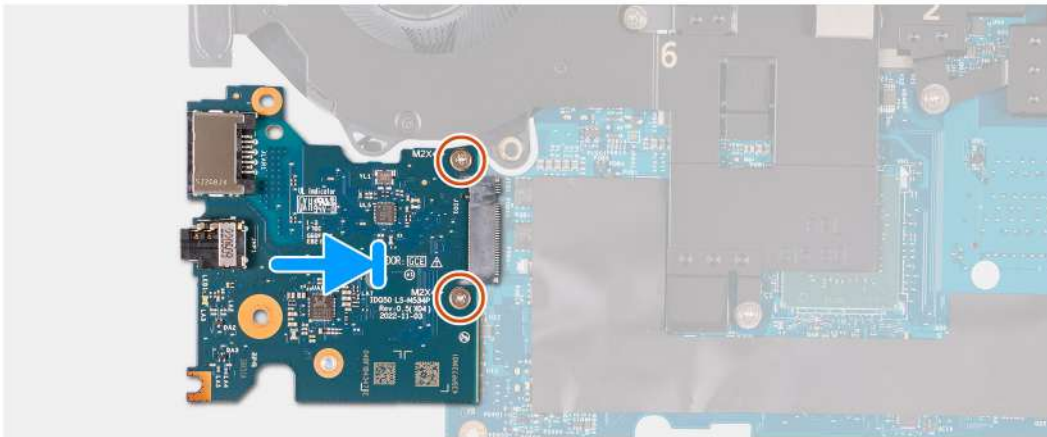

### Steps

1. Slide the ethernet and audio board into the M.2 card slot on the system board.
2. Align the screw holes on the ethernet and audio board to the screw holes on the system board.
3. Replace the two screws (M2x4) that secure the ethernet and audio board to the system board.
4. Turn the system-board assembly over.

### Next steps

1. Install the [system board](#).
2. Install the [memory module](#).
3. Install the [wireless card](#).
4. Install the [solid-state drive](#).
5. Install the [rear cover](#).
6. Install the [battery](#).
7. Install the [base cover](#).
8. Follow the procedure in [After working inside your computer](#).

## Fan and heat-sink assembly

### Removing the fan and heat-sink assembly

#### Prerequisites

1. Follow the procedure in [Before working inside your computer](#).

**CAUTION:** For maximum cooling of the processor, do not touch the heat transfer areas on the heat sink. The oils in your skin can reduce the heat transfer capability of the thermal grease.

**NOTE:** The heat sink may become hot during normal operation. Allow sufficient time for the heat sink to cool before you touch it.

2. Remove the [base cover](#).
3. Remove the [battery](#).
4. Remove the [rear cover](#).

5. Remove the [solid-state drive](#).
6. Remove the [wireless card](#).
7. Remove the [memory module](#).
8. Remove the [system board](#).

**NOTE:** The system board can be removed as an assembly with the fan and heat-sink assembly, ethernet and audio board, and USB board attached.

**About this task**

The following image indicates the location of the fan and heat-sink assembly and provides a visual representation of the removal procedure.

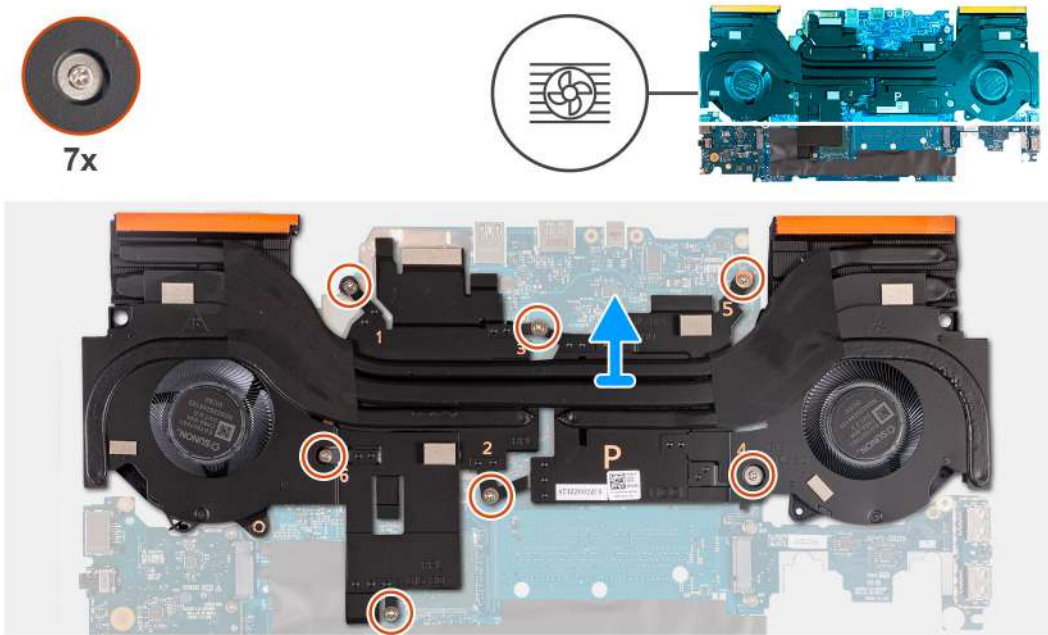

**Steps**

1. Turn the system-board assembly over.
2. In sequential order (1>2>3>4>5>6>7), remove the seven screws that secure the fan and heat-sink assembly to the system-board assembly.
3. Lift the fan and heat-sink assembly off the system-board assembly.

## Installing the fan and heat-sink assembly

**Prerequisites**

If you are replacing a component, remove the existing component before performing the installation procedure.

**About this task**

The following image indicates the location of the fan and heat-sink assembly and provides a visual representation of the installation procedure.

**NOTE:** If either the system board or the heat sink is replaced, use the thermal pad that is provided in the kit to ensure that thermal conductivity is achieved.

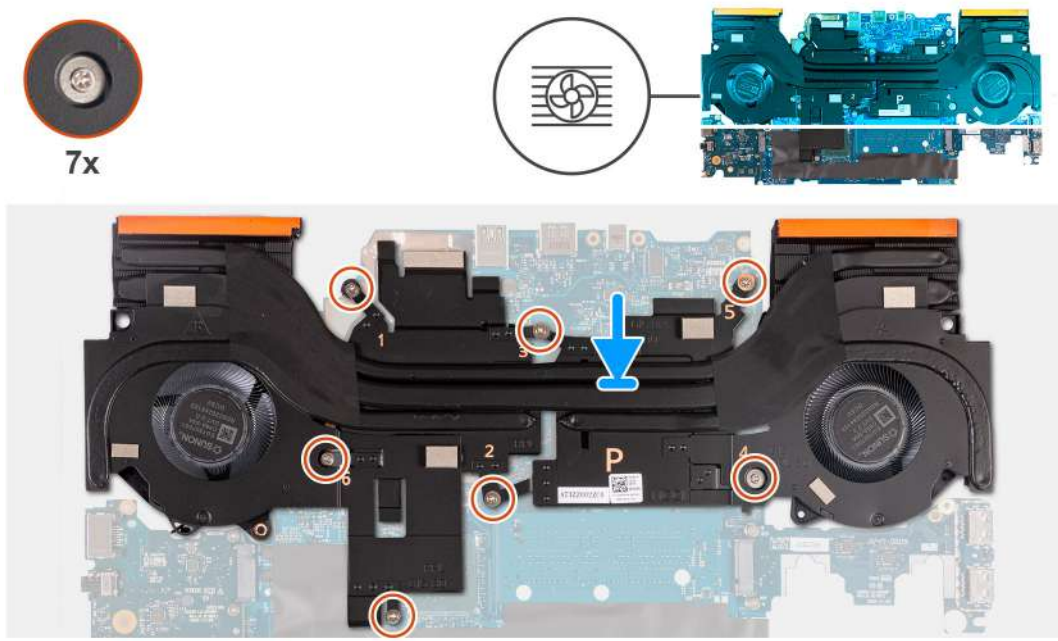

**Steps**

1. Place the fan and heat-sink assembly on the system board and align the screw holes on the fan and heat-sink assembly with the screw holes on the system board.
2. In reverse sequential order (7>6>5>4>3>2>1), replace the seven screws that secure the fan and heat-sink assembly to the system board.
3. Turn the system-board assembly over.

**Next steps**

1. Install the [system board](#).
2. Install the [memory module](#).
3. Install the [wireless card](#).
4. Install the [solid-state drive](#).
5. Install the [rear cover](#).
6. Install the [battery](#).
7. Install the [base cover](#).
8. Follow the procedure in [After working inside your computer](#).

# Power-button assembly

## Removing the power button

**Prerequisites**

1. Follow the procedure in [Before working inside your computer](#).
2. Remove the [base cover](#).
3. Remove the [battery](#).
4. Remove the [rear cover](#).
5. Remove the [solid-state drive](#).
6. Remove the [wireless card](#).
7. Remove the [memory module](#).
8. Remove the [system board](#).

**NOTE:** The system board can be removed as an assembly with the fan and heat-sink assembly, ethernet and audio board, and USB board attached.

### About this task

The following images indicate the location of the power button and provide a visual representation of the removal procedure.

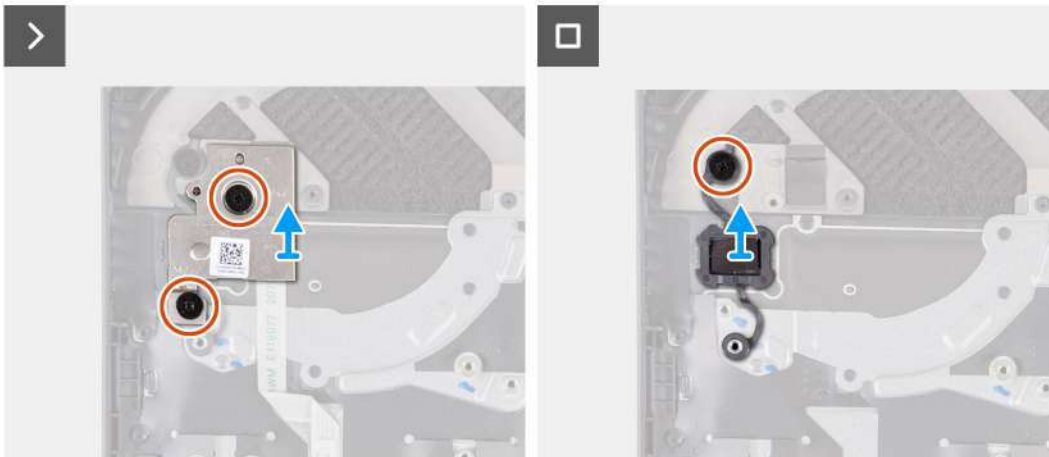
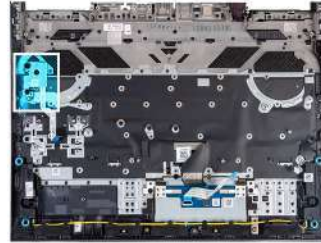

### Steps

1. Remove the two screws (M2x2) that secure the power-button board assembly to the palm-rest and keyboard assembly.
2. Lift the power-button board assembly off the palm-rest and keyboard assembly.
3. Remove the screw (M2x2) that secures the power button to the palm-rest and keyboard assembly.
4. Lift the power button off the palm-rest and keyboard assembly.

## Installing the power button

### Prerequisites

If you are replacing a component, remove the existing component before performing the installation procedure.

### About this task

The following image indicates the location of the power button and provides a visual representation of the installation procedure.



3x  
M2x2

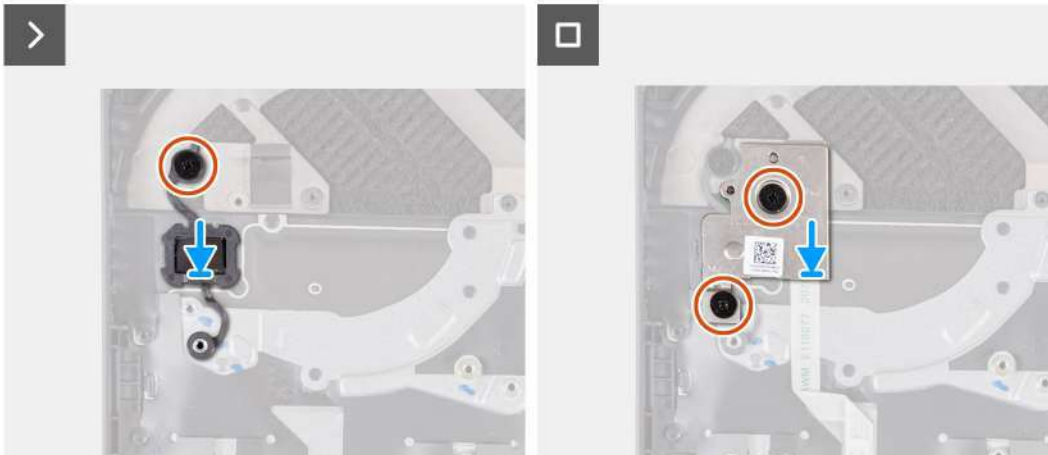
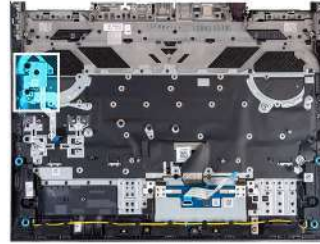

### Steps

1. Place the power button on the slot on the palm-rest and keyboard assembly.
2. Replace the screw (M2x2) that secures the power button to the palm-rest and keyboard assembly.
3. Align the screw holes on the power-button board assembly with the screw holes on the palm-rest and keyboard assembly.
4. Replace the two screws (M2x2) that secure the power-button board assembly to the palm-rest and keyboard assembly.

### Next steps

1. Install the [system board](#).
2. Install the [memory module](#).
3. Install the [wireless card](#).
4. Install the [solid-state drive](#).
5. Install the [rear cover](#).
6. Install the [battery](#).
7. Install the [base cover](#).
8. Follow the procedure in [After working inside your computer](#).

## Palm-rest and keyboard assembly

### Removing the palm-rest and keyboard assembly

#### Prerequisites

1. Follow the procedure in [Before working inside your computer](#).
2. Remove the [base cover](#).
3. Remove the [battery](#).
4. Remove the [rear cover](#).
5. Remove the [touchpad](#).
6. Remove the [display assembly](#).
7. Remove the [solid-state drive](#).
8. Remove the [wireless card](#).



9. Remove the [memory module](#).
10. Remove the [speakers](#).
11. Remove the [power adapter port](#).
12. Remove the [system board](#).

**i NOTE:** The system board can be removed as an assembly with the fan and heat-sink assembly, ethernet and audio board, and USB board attached.

13. Remove the [keyboard-controller board](#), if applicable.
14. Remove the [power-button assembly](#).

### About this task

After performing the steps in the pre-requisites, we are left with the palm-rest and keyboard assembly.

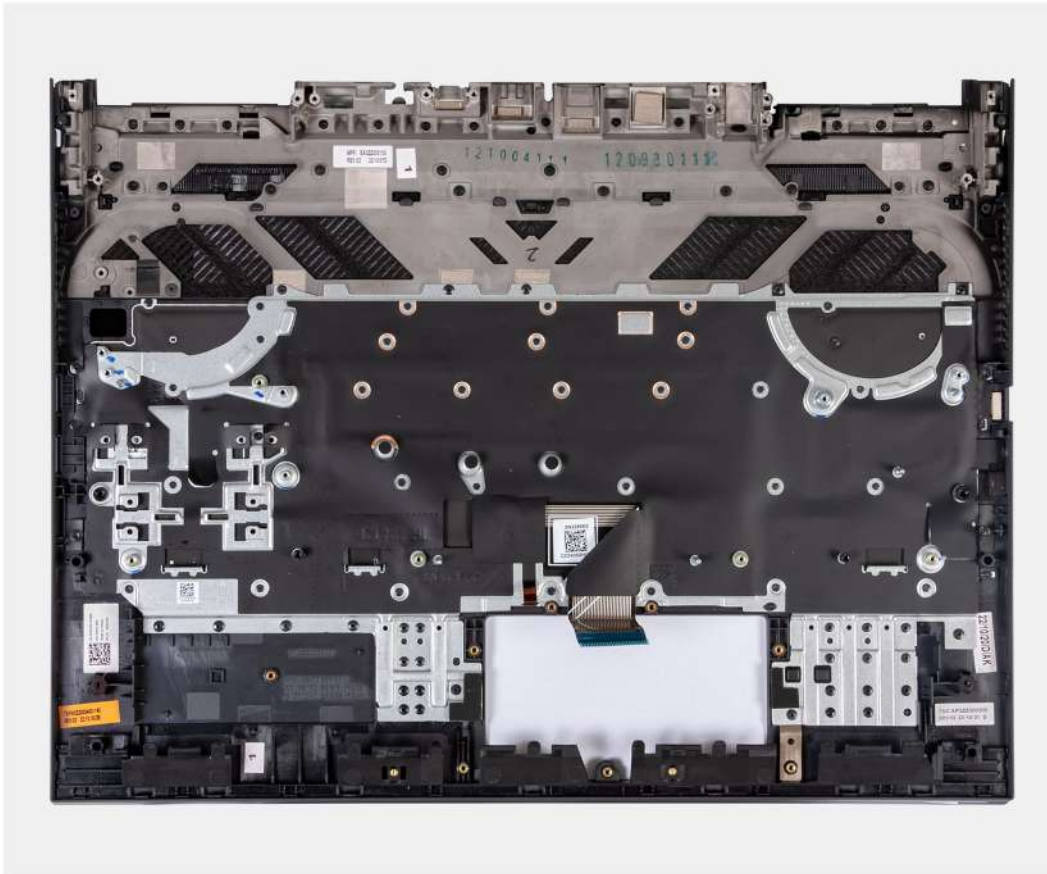

**i NOTE:** When replacing the palm-rest and keyboard assembly, the solid-state drive screw mount must be removed from the existing palm-rest and keyboard assembly and transferred to the replacement palm-rest and keyboard assembly.

## Installing the palm-rest and keyboard assembly

### Prerequisites

If you are replacing a component, remove the existing component before performing the installation procedure.

### About this task

Place the palm-rest and keyboard assembly on a flat surface.

**i NOTE:** When replacing the palm-rest and keyboard assembly, the solid-state drive screw mount must be transferred from the old palm-rest and keyboard assembly to the replacement palm-rest and keyboard assembly.

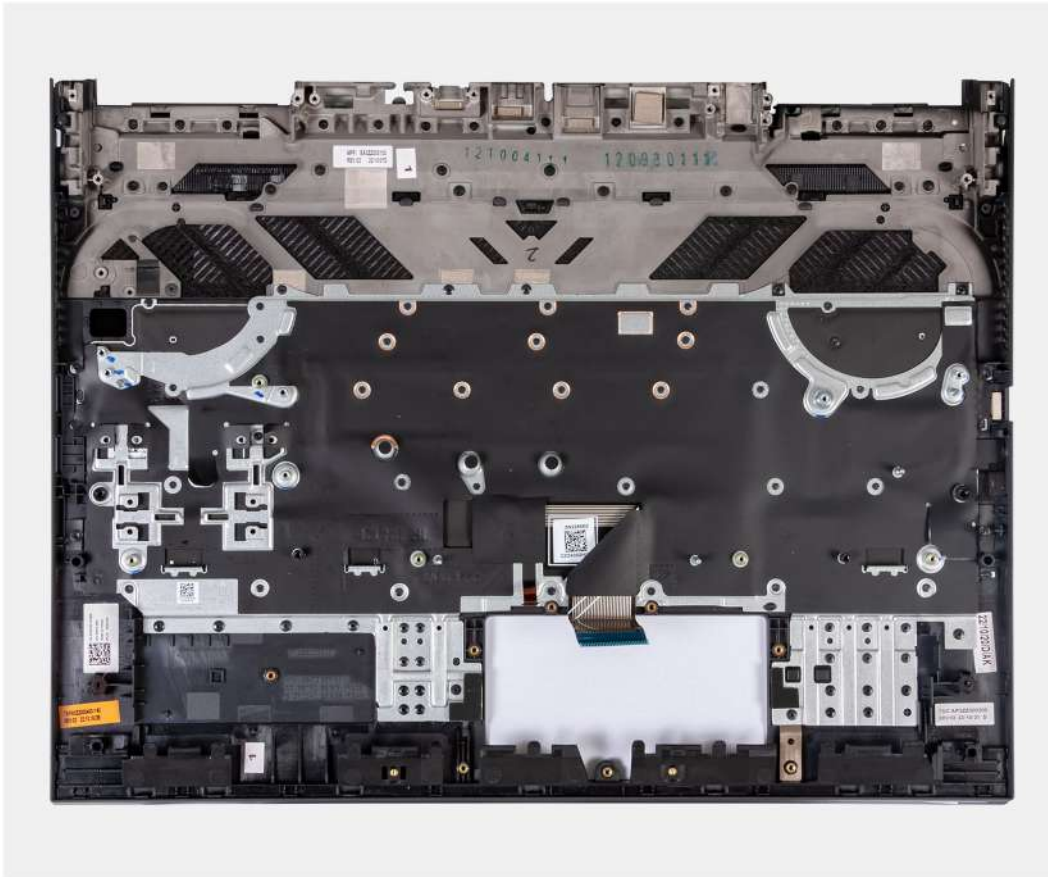

### Next steps

1. Install the [power-button assembly](#).
2. Install the [system board](#).
  - i** **NOTE:** The system board can be installed as an assembly with the fan and heat-sink assembly, ethernet and audio board, and USB board attached.
3. Install the [keyboard-controller board](#), if applicable.
4. Install the [power adapter port](#).
5. Install the [speakers](#).
6. Install the [memory module](#).
7. Install the [wireless card](#).
8. Install the [solid-state drive](#).
9. Install the [display assembly](#).
10. Install the [touchpad](#).
11. Install the [rear cover](#).
12. Install the [battery](#).
13. Install the [base cover](#).
14. Follow the procedure in [After working inside your computer](#).



# Software

This chapter details the supported operating systems along with instructions on how to install the drivers.

## Operating system

Your Dell G15 5530 supports the following operating systems:

- Windows 11 Professional, 64-bit
- Windows 11 Home, 64-bit
- Ubuntu 20.04 LTS, 64-bit

## Drivers and downloads

When troubleshooting, downloading or installing drivers it is recommended that you read the Dell Knowledge Base article, Drivers and Downloads FAQ [000123347](#).

# Technology and components

 **NOTE:** Instructions provided in this section are applicable on computers shipped with Windows operating system. Windows is factory-installed with this computer.

# BIOS setup

**CAUTION:** Unless you are an expert computer user, do not change the settings in the BIOS Setup program. Certain changes can make your computer work incorrectly.

**NOTE:** Depending on the computer and its installed devices, the items listed in this section may or may not be displayed.

**NOTE:** Before you change BIOS Setup program, it is recommended that you write down the BIOS Setup program screen information for future reference.

Use the BIOS Setup program for the following purposes:

- Get information about the hardware installed in your computer, such as the amount of RAM and the size of the hard drive.
- Change the system configuration information.
- Set or change a user-selectable option, such as the user password, type of hard drive installed, and enabling or disabling base devices.

## Entering BIOS setup program

### About this task

Turn on (or restart) your computer and press F2 immediately.

## Navigation keys

**NOTE:** For most of the System Setup options, changes that you make are recorded but do not take effect until you restart the system.

**Table 26. Navigation keys**

Keys	Navigation
Up arrow	Moves to the previous field.
Down arrow	Moves to the next field.
Enter	Selects a value in the selected field (if applicable) or follow the link in the field.
Spacebar	Expands or collapses a drop-down list, if applicable.
Tab	Moves to the next focus area. <b>NOTE:</b> For the standard graphics browser only.
Esc	Moves to the previous page until you view the main screen. Pressing Esc in the main screen displays a message that prompts you to save any unsaved changes and restarts the system.

## One Time Boot menu

To enter **One Time Boot menu**, turn on your computer, and then press F12 immediately.

**NOTE:** It is recommended to shutdown the computer if it is on.

The one-time boot menu displays the devices that you can boot from including the diagnostic option. The boot menu options are:

- Removable Drive (if available)
- STXXXX Drive (if available)
- **i** **NOTE:** XXX denotes the SATA drive number.
- Optical Drive (if available)
- SATA Hard Drive (if available)
- Diagnostics

The boot sequence screen also displays the option to access the System Setup screen.

## System setup options

**i** **NOTE:** Depending on this computer and its installed devices, the items that are listed in this section may or may not be displayed.

**Table 27. System setup options—System information menu**

Overview	
BIOS Version	Displays the BIOS version number.
Service Tag	Displays the Service Tag of the computer.
Asset Tag	Displays the Asset Tag of the computer.
Manufacture Date	Displays the manufacture date of the computer.
Ownership Date	Displays the ownership date of the computer.
Express Service Code	Displays the express service code of the computer.
Ownership Tag	Displays the ownership tag of the computer.
Signed Firmware Update	Displays whether the signed firmware update is enabled.
<b>Battery</b>	Displays the battery health information.
Primary	Displays the primary battery.
Battery Level	Displays the battery level.
Battery State	Displays the battery state.
Health	Displays the battery health.
AC Adapter	Displays whether an AC adapter is installed.
<b>Processor</b>	
Processor Type	Displays the processor type.
Maximum Clock Speed	Displays the maximum processor clock speed.
Minimum Clock Speed	Displays the minimum processor clock speed.
Current Clock Speed	Displays the current processor clock speed.
Core Count	Displays the number of cores on the processor.
Processor ID	Displays the processor identification code.
Processor L2 Cache	Displays the processor L2 Cache size.
Processor L3 Cache	Displays the processor L3 Cache size.
Microcode Version	Displays the microcode version.
Intel Hyper-Threading Capable	Displays whether the processor is Hyper-Threading (HT) capable.
64-Bit Technology	Displays whether 64-bit technology is used.
<b>Memory</b>	

**Table 27. System setup options—System information menu (continued)**

<b>Overview</b>	
Memory Installed	Displays the total computer memory installed.
Memory Available	Displays the total computer memory available.
Memory Speed	Displays the memory speed.
Memory Channel Mode	Displays single or dual channel mode.
Memory Technology	Displays the technology that is used for the memory.
DIMM_Slot A	Displays the DIMM A memory size.
DIMM_Slot B	Displays the DIMM B memory size.
<b>Devices</b>	
Panel Type	Displays the Panel Type of the computer.
Video Controller	Displays the integrate graphics information of the computer.
Video Memory	Displays the video memory information of the computer.
Wi-Fi Device	Displays the wireless device information of the computer.
Native Resolution	Displays the native resolution of the computer.
Video BIOS Version	Displays the video BIOS version of the computer.
Bluetooth Device	Displays the Bluetooth device information of the computer.
Audio Controller	Displays the audio controller information of the computer.
LOM MAC Address	Displays the LOM MAC address of the computer.
dGPU Video Controller	Displays the discrete graphics information of the computer.

**Table 28. System setup options—Boot Configuration menu**

<b>Boot Configuration</b>	
<b>Boot Sequence</b>	
Boot Mode: UEFI only	Displays the boot mode of this computer.
Boot Sequence	Enables to set the boot order.
<b>Secure Boot</b>	
Enable Secure Boot	Enables secure boot using only validated boot software. Default: ON
Enable Microsoft UEFI CA	Enables Microsoft UEFI CA. Default: ON
Secure Boot Mode	Changes to the Secure Boot operation mode. Allows to switch between Deployed Mode and Audit Mode. Default: Deployed Mode
<b>Expert Key Management</b>	
Enable Custom Mode	Allows the PK, KEK, db, and dbx security key databases to be modified. Default: OFF
Custom Mode Key Management	Allows for selection of key database.

**Table 29. System setup options—Integrated Devices menu**

<b>Integrated Devices</b>	
<b>Date/Time</b>	

**Table 29. System setup options—Integrated Devices menu (continued)**

<b>Integrated Devices</b>	
Date	Sets the computer date in MM/DD/YYYY format. Changes to the date take effect immediately.
Time	Sets the computer time in HH/MM/SS 24-hour format. You can switch between 12-hour and 24-hour clock. Changes to the time take effect immediately.
<b>Memory Mapped I/O above 4 Gig</b>	Enables or disables the Memory Mapped I/O above 4 GB. Default: ON
<b>Camera</b>	
Enable Camera	Enables or disables the camera. By default, Enable Camera is selected.
<b>Audio</b>	
Enable Audio	Enables or disables all integrated audio controller. Default: ON
Enable Microphone	Enables or disables microphone. By default, Enable Microphone is selected.
Enable Internal Speaker	Enables or disables internal speaker. By default, Enable Internal Speaker is selected.
<b>USB Configuration</b>	
Enable External USB Ports	Enables or disables external USB ports. Default: ON
Enable USB Boot Support	Enables or disables USB Boot Support. Default: ON

**Table 30. System setup options—Storage menu**

<b>Storage</b>	
<b>SATA/NVMe Operation</b>	
SATA/NVMe Operation	Configures operating mode of the integrated storage device controller. Default: RAID On. Storage device is configured to support RAID functions. When enabled, all NVMe and SATA devices will be mapped under VMD controller. Windows RST (Intel Rapid Restore Technology) driver, or Linux kernel VMD driver must be loaded in order to boot the OS.
<b>Storage Interface</b>	
Port Enablement	Enables or disables the onboard drives. Default: ON
<b>SMART Reporting</b>	
Enable SMART Reporting	Enables or disables Self-Monitoring, Analysis, and Reporting Technology (SMART). Default: ON
<b>Drive Information</b>	Displays the information of various onboard drives.

**Table 31. System setup options—Display menu**

Display	
<b>Display Brightness</b>	
Brightness on battery power	Sets the screen brightness when the computer is running on battery power.
Brightness on AC power	Sets the screen brightness when the computer is running on AC power.
<b>Full Screen Logo</b>	
	Enables or disables full screen logo. By default, this option is disabled.
<b>Hybrid Graphics/Advanced Optimus</b>	
Enable Hybrid Graphics/Advanced Optimus (when available)	Enables or disables Hybrid Graphics/Advanced Optimus. Default: ON.

**Table 32. System setup options—Connection menu**

Connection	
<b>Network Controller Configuration</b>	
Integrated NIC	Enable or disable the on-board LAN controller. By default, the Enabled with PXE option is enabled.
<b>Wireless Device Enable</b>	
WLAN	Enable or disable the internal WLAN device. By default, this option is selected.
Bluetooth	Enable or disable the internal Bluetooth device By default, this option is selected.
<b>Enable UEFI Network Stack</b>	
	Enable or disable UEFI Network Stack and controls the on-board LAN Controller. By default, the Enabled option is selected.
<b>HTTPs Boot Feature</b>	
HTTPs Boot	Enable or disable the HTTPs Boot feature. Default: ON.
HTTPs Boot Modes	With Auto Mode, the HTTPs Boot extracts Boot URL from the DHCP. With Manual Mode, the HTTPs Boot reads Boot URL from the user-provided data. By default, the Auto Mode option is enabled.
Upload	Enables you to upload the CA certificate.
Delete	Enables you to delete the CA certificate.

**Table 33. System setup options—Power menu**



Power	
<b>Battery Configuration</b>	
	Enables the computer to run on battery during peak power usage hours. Use the Custom Charge Start and Custom Charge Stop options to prevent AC power usage between certain times of each day. By default, the Adaptive option is enabled.
<b>Advanced Configuration</b>	
Enable Advanced Battery Charge Configuration	Enables or disables the advanced battery charge configuration. Default: OFF



**Table 33. System setup options—Power menu (continued)**

Power	
	If enabled, use the Beginning of Day and Work Period sections to configure the daily times and work periods.
<b>Thermal Management</b>	Enables to cool the fan and processor heat management to adjust the system performance, noise, and temperature. By default, the Optimized option is selected.
<b>Block Sleep</b>	Enables to block entering Sleep (S3) mode in the operating system. Default: OFF
<b>Lid Switch</b>	
Enable Lid Switch	Enables or disables the Lid Switch Default: ON
Power On Lid Open	When enabled, allows the system to power up from the off state whenever the lid is opened. Default: ON
<b>Intel Speed Shift Technology</b>	Enable or disable the Intel Speed Shift Technology support. Default: ON

**Table 34. System setup options—Security menu**

Security	
<b>Intel Platform Trust Technology</b>	
Intel Platform Trust Technology On	Enables or disables Intel Platform Trust Technology visibility to operating system. Default: ON
PPI Bypass for Clear Commands	Controls the TPM Physical Presence Interface (PPI). By default, this option is disabled.
Clear	Enables to clear the PTT owner information and returns the PTT to the default state. By default, this option is disabled.
<b>SMM Security Mitigation</b>	Enables or disables additional UEFI SMM Security Mitigation protections. Default: ON
<b>Data Wipe on Next Boot</b>	
Start Data Wipe	Enables or disables the data wipe on next boot. Default: OFF
<b>Absolute</b>	Enables, disables, or permanently disables the BIOS module interface of the optional Absolute Persistence Module service from Absolute Software. By default, the Enable Absolute option is selected.
	 <b>WARNING:</b> The 'Permanently Disable Absolute' option can only be selected once. When 'Permanently Disable Absolute' is selected, Absolute Persistence cannot be re-enabled. No further changes to the Enable/Disable states are allowed.
	 <b>NOTE:</b> The Enable/Disable options are unavailable while Computrace is in the activated state.

**Table 34. System setup options—Security menu (continued)**

Security	
<b>UEFI Boot Path Security</b>	Controls whether the system prompts the user to enter the admin password (if set) when booting to a UEFI boot path device from the F12 boot menu.  By default, the <b>Always Except Internal HDD</b> option is selected.

**Table 35. System setup options—Passwords menu**

Passwords	
<b>Admin Password</b>	Set, change, or delete the administrator password.
<b>System Password</b>	Set, change, or delete the system password.
<b>M.2 PCIe SSD-1</b>	Set, change, or delete the NVMe SSD-1 password.
<b>Password Configuration</b>	
Upper Case Letter	Reinforces password to have at least one upper case letter.  By default, the option is disabled.
Lower Case Letter	Reinforces password to have at least one lower case letter.  By default, the option is disabled.
Digit	Reinforces password to have at least one digit number.  By default, the option is disabled.
Special Character	Reinforces password to have at least one special character.  By default, the option is disabled.
Minimum Characters	Set the minimum characters allowed for password.
Password Bypass	When enabled, this always prompts for system and internal hard drive passwords when powered on from the Off state.  By default, the <b>Disabled</b> option is selected.
<b>Password Changes</b>	
Allow Non-Admin Password Changes	Enables or disables to change system and hard drive password without the need for admin password.  Default: ON
<b>Admin Setup Lockout</b>	
Enable Admin Setup Lockout	Enables administrators control over how their users can or cannot access BIOS setup.  Default: OFF
<b>Master Password Lockout</b>	
Enable Master Password Lockout	When enabled, this disables the master password support.  Default: OFF
<b>Allow Non-Admin PSID Revert</b>	
Enable Allow Non-Admin PSID Revert	Controls access to the Physical Security ID (PSID) revert of NVMe hard-drives from the Dell Security Manager prompt.  Default: OFF

**Table 36. System setup options—Update, Recovery menu**

Update, Recovery	
<b>UEFI Capsule Firmware Updates</b>	

**Table 36. System setup options—Update, Recovery menu (continued)**

Update, Recovery	
Enable UEFI Capsule Firmware Updates	<p>Enable or disable BIOS updates through UEFI capsule update packages.</p> <p><b>i</b> <b>NOTE:</b> Disabling this option blocks BIOS updates from services such as Microsoft Windows Update and Linux Vendor Firmware Service (LVFS).</p> <p>Default: ON</p>
<b>BIOS Recovery from Hard Drive</b>	<p>Enables to recover from certain corrupted BIOS conditions from a recovery file on the user primary hard drive or an external USB key.</p> <p>Default: ON</p> <p><b>i</b> <b>NOTE:</b> BIOS Recovery from Hard Drive is not available for self-encrypting drives (SED).</p>
<b>BIOS Downgrade</b>	
Allow BIOS Downgrade	<p>Controls the flashing of the system firmware to previous revisions.</p> <p>Default: ON</p>
<b>SupportAssist OS Recovery</b>	<p>Enables or disables the boot flow for SupportAssist OS Recovery tool in the event of certain system errors.</p> <p>Default: ON</p>
<b>BIOSConnect</b>	<p>Enables or disables cloud Service operating system recovery if the main operating system fails to boot with the number of failures equal to or greater than the value specified by the Auto operating system Recovery Threshold setup option and local Service operating system does not boot or is not installed.</p> <p>Default: ON</p>
<b>Dell Auto operating system Recovery Threshold</b>	<p>Controls the automatic boot flow for SupportAssist System Resolution Console and for Dell operating system Recovery Tool.</p> <p>By default, the threshold value is set to 2.</p>

**Table 37. System setup options—System Management menu**

System Management	
<b>Service Tag</b>	Displays the Service Tag of the system.
<b>Asset Tag</b>	Enables to create a system Asset Tag.
<b>AC Behavior</b>	
Wake on AC	<p>Enables or disables the wake on AC option.</p> <p>Default: OFF</p>
<b>Auto On Time</b>	<p>Enables to set the system to turn on automatically every day or on a preselected date and time. This option can be configured only if the Auto On Time is set to Everyday, Weekdays, or Selected Days.</p> <p>By default, the <b>Disabled</b> option is selected.</p>
<b>First Power On Date</b>	
Set Ownership Date	<p>Enables to set the ownership date.</p> <p>Default: OFF</p>
<b>Diagnostics</b>	
OS Agent Requests	<p>Enables or disables scheduling of onboard diagnostics on the subsequent boot.</p> <p>Default: ON</p>

**Table 37. System setup options—System Management menu (continued)**

System Management	
<b>Power-on-Self-Test Automatic Recovery</b>	Enables or disables automatic recovery if the computer is unresponsive after the BIOS Power-on-Self Test. Default: ON

**Table 38. System setup options—Keyboard menu**

Keyboard	
<b>Fn Lock Options</b>	Enables or disables the Fn lock options. Default: ON
<b>Lock Mode</b>	Enables or disables the Function keys to have secondary functions. By default, the Lock Mode Secondary option is enabled. With this option, the F1-F12 keys scan the code for their secondary functions.
<b>Keyboard Illumination</b>	Configures the keyboard illumination settings. By default, the Bright option is enabled.
<b>Keyboard Backlight Timeout on AC</b>	Sets the timeout value for the keyboard backlight when an AC adapter is connected to the system. By default, the <b>1 minute</b> option is enabled.
<b>Keyboard Backlight Timeout on Battery</b>	Sets the timeout value for the keyboard backlight when the computer is running only on battery power. By default, the <b>1 minute</b> option is enabled.

**Table 39. System setup options—Pre-boot Behavior menu**

Pre-boot Behavior	
<b>Adapter Warnings</b>	Enable Adapter Warnings Enables or disables the warning messages during boot when the adapters with less power capacity are detected. Default: ON
<b>Warning and Errors</b>	Sets the action to be taken when a warning or error is encountered. By default, the Prompt on Warnings and Errors option is enabled.
<b>USB-C Warnings</b>	Enables or disables dock warning messages. Default: ON
<b>Fastboot</b>	Allows you to configure the speed of the UEFI boot process. By default, the <b>Thorough</b> option is enabled.
<b>Extend BIOS POST Time</b>	Set the BIOS POST load time. By default, the <b>0 seconds</b> option is enabled.

**Table 40. System setup options—Virtualization menu**

Virtualization	
<b>Intel Virtualization Technology</b>	Enable Intel Virtualization Technology (VT) When enabled, the system can run a Virtual Machine Monitor (VMM). Default: ON
<b>VT for Direct I/O</b>	

**Table 40. System setup options—Virtualization menu (continued)**

<b>Virtualization</b>	
Enable Intel VT for Direct I/O	When enabled, the system can perform Virtualization Technology for Direct I/O (VT-d). Default: ON
<b>DMA Protection</b>	
Enable Pre-Boot DMA Support	This setting controls Pre-boot DMA protection for both internal and external ports. Default: ON
Enable OS Kernel DMA Support	This setting controls Kernel DMA protection for both internal and external ports. Default: ON

**Table 41. System setup options—Performance menu**

<b>Performance</b>	
<b>Multi Core Support</b>	
All Cores	Enables to select all cores to be available to the operating system. By default, this option is disabled.
Active Core Selection	Enables to set the number of CPU cores available to the operating system. By default, this option is disabled.
Multiple Atom Cores	Enables to change the number of Atom cores available to the operating system. By default, the All Cores option is enabled.
<b>Intel SpeedStep</b>	
Enable Intel SpeedStep Technology	Enables the system to dynamically adjust processor voltage and core frequency, decreasing average power consumption and heat production. Default: ON
<b>C-States Control</b>	
Enable C-State Control	Enables the ability of the CPU to enter and exit low power state. When disabled, it disabled all C-states. When enabled, it enabled all C-states that the chipset or platform allows. Default: ON
Enable Adaptive C-States for Discrete Graphics	Enables the ability of the CPU to dynamically detect high usage of a discrete graphic and adjust system parameters for higher performance. Default: ON
<b>Intel Turbo Boost Technology</b>	
Enable Intel Turbo Boost Technology	Enables or disables the Intel TurboBoost mode of the processor. Default: ON
<b>Intel Turbo Boost Maximum Technology 3.0</b>	
Enable Intel Turbo Boost Maximum Technology 3.0	Enables or disables the Intel TurboBoost maximum mode of the processor. Default: ON
<b>Intel Hyper-Threading Technology</b>	
Enable Intel Hyper-Threading Technology	Enables or disables Hyper-Threading in the processor.

**Table 41. System setup options—Performance menu (continued)**

Performance	
<b>OverClocking feature</b>	Default: ON Enables or disables global OverClocking functions. Default: OFF When enabled, OverClocking settings are available for selection.
<b>TCC Activation Offset</b>	Configures the CPU's TCC offset.

**Table 42. System setup options—System Logs menu**

System Logs	
<b>BIOS Event Log</b>	
Clear Bios Event Log	Displays BIOS events. By default, the Keep Log option is enabled.
<b>Thermal Event Log</b>	
Clear Thermal Event Log	Displays Thermal events. By default, the Keep Log option is enabled.
<b>Power Event Log</b>	
Clear Power Event Log	Displays power events. By default, the Keep Log option is enabled.

## Updating the BIOS

### Updating the BIOS in Windows

#### Steps

1. Go to [www.dell.com/support](http://www.dell.com/support).
2. Click **Product support**. In the **Search support** box, enter the Service Tag of your computer, and then click **Search**.  
 **NOTE:** If you do not have the Service Tag, use the SupportAssist feature to automatically identify your computer. You can also use the product ID or manually browse for your computer model.
3. Click **Drivers & Downloads**. Expand **Find drivers**.
4. Select the operating system installed on your computer.
5. In the **Category** drop-down list, select **BIOS**.
6. Select the latest version of BIOS, and click **Download** to download the BIOS file for your computer.
7. After the download is complete, browse the folder where you saved the BIOS update file.
8. Double-click the BIOS update file icon and follow the on-screen instructions.  
For more information about how to update the system BIOS, search in the Knowledge Base Resource at [www.dell.com/support](http://www.dell.com/support).

### Updating the BIOS using the USB drive in Windows

#### Steps

1. Follow the procedure from step 1 to step 6 in [Updating the BIOS in Windows](#) to download the latest BIOS setup program file.
2. Create a bootable USB drive. For more information, search the Knowledge Base Resource at [www.dell.com/support](http://www.dell.com/support).

3. Copy the BIOS setup program file to the bootable USB drive.
4. Connect the bootable USB drive to the computer that needs the BIOS update.
5. Restart the computer and press **F12** .
6. Select the USB drive from the **One Time Boot Menu**.
7. Type the BIOS setup program filename and press **Enter**.  
The **BIOS Update Utility** appears.
8. Follow the on-screen instructions to complete the BIOS update.

## Updating the BIOS in Linux and Ubuntu

To update the system BIOS on a computer that is installed with Linux or Ubuntu, see the knowledge base article [000131486](https://www.dell.com/support) at [www.dell.com/support](https://www.dell.com/support).

## Updating the BIOS from the F12 One Time Boot menu

Update your computer BIOS using the BIOS update.exe file that is copied to a FAT32 USB drive and booting from the F12 **One Time Boot** menu.

### About this task

#### BIOS Update

You can run the BIOS update file from Windows using a bootable USB drive or you can also update the BIOS from the F12 **One Time Boot** menu on the computer.

Most of the Dell computers built after 2012 have this capability, and you can confirm by booting your computer to the F12 **One Time Boot** Menu to see if BIOS FLASH UPDATE is listed as a boot option for your computer. If the option is listed, then the BIOS supports this BIOS update option.

 **NOTE:** Only computers with BIOS Flash Update option in the F12 **One Time Boot** menu can use this function.

#### Updating from the One Time Boot menu

To update your BIOS from the F12 **One Time Boot** menu, you need the following:

- USB drive formatted to the FAT32 file system (key does not have to be bootable)
- BIOS executable file that you downloaded from the Dell Support website and copied to the root of the USB drive
- AC power adapter that is connected to the computer
- Functional computer battery to flash the BIOS

Perform the following steps to perform the BIOS update flash process from the F12 menu:

 **CAUTION: Do not turn off the computer during the BIOS update process. The computer may not boot if you turn off your computer.**

#### Steps

1. From a turn off state, insert the USB drive where you copied the flash into a USB port of the computer.
2. Turn on the computer and press F12 to access the **One Time Boot** Menu, select BIOS Update using the mouse or arrow keys then press Enter.  
The flash BIOS menu is displayed.
3. Click **Flash from file**.
4. Select external USB device.
5. Select the file and double-click the flash target file, and then click **Submit**.
6. Click **Update BIOS**. The computer restarts to flash the BIOS.
7. The computer will restart after the BIOS update is completed.



# System and setup password

Table 43. System and setup password

Password type	Description
System password	Password that you must enter to log in to your system.
Setup password	Password that you must enter to access and make changes to the BIOS settings of your computer.

You can create a system password and a setup password to secure your computer.

 **CAUTION:** The password features provide a basic level of security for the data on your computer.

 **CAUTION:** Anyone can access the data that is stored on your computer if it is not locked and left unattended.

 **NOTE:** System and setup password feature is disabled.

## Assigning a system setup password

### Prerequisites

You can assign a new **System or Admin Password** only when the status is in **Not Set**.

### About this task

To enter the system setup, press F12 immediately after a power-on or reboot.

### Steps

1. In the **System BIOS** or **System Setup** screen, select **Security** and press Enter.  
The **Security** screen is displayed.
2. Select **System/Admin Password** and create a password in the **Enter the new password** field.  
Use the following guidelines to assign the system password:
  - A password can have up to 32 characters.
  - At least one special character: ! " # \$ % & ' ( ) \* + , - . / : ; < = > ? @ [ \ ] ^ \_ ` { | }
  - Numbers 0 through 9.
  - Upper case letters from A to Z.
  - Lower case letters from a to z.
3. Type the system password that you entered earlier in the **Confirm new password** field and click **OK**.
4. Press Esc and save the changes as prompted by the pop-up message.
5. Press Y to save the changes.  
The computer restarts.

## Deleting or changing an existing system setup password

### Prerequisites

Ensure that the **Password Status** is Unlocked (in the System Setup) before attempting to delete or change the existing System and/or Setup password. You cannot delete or change an existing System or Setup password, if the **Password Status** is Locked.

### About this task

To enter the System Setup, press F12 immediately after a power-on or reboot.

### Steps

1. In the **System BIOS** or **System Setup** screen, select **System Security** and press Enter.  
The **System Security** screen is displayed.
2. In the **System Security** screen, verify that **Password Status** is **Unlocked**.
3. Select **System Password**, update, or delete the existing system password, and press Enter or Tab.
4. Select **Setup Password**, update, or delete the existing setup password, and press Enter or Tab.  
 **NOTE:** If you change the System and/or Setup password, reenter the new password when prompted. If you delete the System and/or Setup password, confirm the deletion when prompted.
5. Press Esc and a message prompts you to save the changes.
6. Press Y to save the changes and exit from System Setup.  
The computer restarts.

## Clearing CMOS settings

### About this task

 **CAUTION:** Clearing CMOS settings will reset the BIOS settings on your computer.

### Steps

1. Remove the [base cover](#).
2. Disconnect the battery cable from the system board.
3. Wait for one minute.
4. Connect the battery cable to the system board.
5. Replace the [base cover](#).

## Clearing BIOS (System Setup) and System passwords

### About this task

To clear the system or BIOS passwords, contact Dell technical support as described at [www.dell.com/contactdell](http://www.dell.com/contactdell).

 **NOTE:** For information on how to reset Windows or application passwords, refer to the documentation accompanying Windows or your application.

## Troubleshooting

### Handling swollen rechargeable Li-ion batteries

Like most laptops, Dell laptops use Lithium-ion batteries. One type of Lithium-ion battery is the rechargeable Li-ion battery. Rechargeable Li-ion batteries have increased in popularity in recent years and have become standard in the electronics industry due to customer preferences for a slim form factor (especially with newer ultra-thin laptops) and long battery life. Inherent to rechargeable Li-ion battery technology is the potential for swelling of the battery cells.

Swollen battery may impact the performance of the laptop. To prevent possible further damage to the device enclosure or internal components leading to malfunction, discontinue the use of the laptop and discharge it by disconnecting the AC adapter and letting the battery drain.

Swollen batteries should not be used and should be replaced and disposed of properly. We recommend contacting Dell product support for options to replace a swollen battery under the terms of the applicable warranty or service contract, including options for replacement by a Dell authorized service technician.

The guidelines for handling and replacing rechargeable Li-ion batteries are as follows:

- Exercise caution when handling rechargeable Li-ion batteries.
- Discharge the battery before removing it from the system. To discharge the battery, unplug the AC adapter from the system and operate the system only on battery power. When the system will no longer power on when the power button is pressed, the battery is fully discharged.
- Do not crush, drop, mutilate, or penetrate the battery with foreign objects.
- Do not expose the battery to high temperatures, or disassemble battery packs and cells.
- Do not apply pressure to the surface of the battery.
- Do not bend the battery.
- Do not use tools of any type to pry on or against the battery.
- If a battery gets stuck in a device as a result of swelling, do not try to free it as puncturing, bending, or crushing a battery can be dangerous.
- Do not attempt to reassemble a damaged or swollen battery into a laptop.
- Swollen batteries that are covered under warranty should be returned to Dell in an approved shipping container (provided by Dell)—this is to comply with transportation regulations. Swollen batteries that are not covered under warranty should be disposed of at an approved recycling center. Contact Dell product support at <https://www.dell.com/support> for assistance and further instructions.
- Using a non-Dell or incompatible battery may increase the risk of fire or explosion. Replace the battery only with a compatible battery purchased from Dell that is designed to work with your Dell computer. Do not use a battery from other computers with your computer. Always purchase genuine batteries from <https://www.dell.com> or otherwise directly from Dell.

Rechargeable Li-ion batteries can swell for various reasons such as age, number of charge cycles, or exposure to high heat. For more information on how to improve the performance and lifespan of the laptop battery and to minimize the possibility of occurrence of the issue, search Dell Laptop Battery in the Knowledge Base Resource at [www.dell.com/support](http://www.dell.com/support).

### Locate the Service Tag or Express Service Code of your Dell computer

Your Dell computer is uniquely identified by a Service Tag or Express Service Code. To view relevant support resources for your Dell computer, we recommend entering the Service Tag or Express Service Code at [www.dell.com/support](http://www.dell.com/support).

For more information on how to find the Service Tag for your computer, see [Locate the Service Tag on your computer](#).

# Dell SupportAssist Pre-boot System Performance Check diagnostics

## About this task

SupportAssist diagnostics (also known as system diagnostics) performs a complete check of your hardware. The Dell SupportAssist Pre-boot System Performance Check diagnostics is embedded with the BIOS and is launched by the BIOS internally. The embedded system diagnostics provides a set of options for particular devices or device groups allowing you to:

- Run tests automatically or in an interactive mode
- Repeat tests
- Display or save test results
- Run thorough tests to introduce additional test options to provide extra information about the failed device(s)
- View status messages that inform you if tests are completed successfully
- View error messages that inform you of problems encountered during testing

 **NOTE:** Some tests for specific devices require user interaction. Always ensure that you are present at the computer terminal when the diagnostic tests are performed.

For more information, see <https://www.dell.com/support/kbdoc/000180971>.

## Running the SupportAssist Pre-Boot System Performance Check

### Steps

1. Turn on your computer.
2. As the computer boots, press the F12 key as the Dell logo appears.
3. On the boot menu screen, select the **Diagnostics** option.
4. Click the arrow at the bottom left corner.  
Diagnostics front page is displayed.
5. Click the arrow in the lower-right corner to go to the page listing.  
The items detected are listed.
6. To run a diagnostic test on a specific device, press Esc and click **Yes** to stop the diagnostic test.
7. Select the device from the left pane and click **Run Tests**.
8. If there are any issues, error codes are displayed.  
Note the error code and validation number and contact Dell.

## Built-in self-test (BIST)

### M-BIST

M-BIST (Built In Self-Test) is the system board's built-in self-test diagnostics tool that improves the diagnostics accuracy of system board embedded controller (EC) failures.

 **NOTE:** M-BIST can be manually initiated before POST (Power On Self Test).

### How to run M-BIST

 **NOTE:** M-BIST must be initiated on the system from a power-off state either connected to AC power or with battery only.

1. Press and hold both the **M** key on the keyboard and the **power button** to initiate M-BIST.
2. With both the **M** key and the **power button** held down, the battery indicator LED may exhibit two states:
  - a. OFF: No fault detected with the system board
  - b. AMBER: Indicates a problem with the system board
3. If there is a failure with the system board, the battery status LED will flash one of the following error codes for 30 seconds:

**Table 44. LED error codes**

Blinking Pattern		Possible Problem
Amber	White	
2	1	CPU Failure
2	8	LCD Power Rail Failure
1	1	TPM Detection Failure
2	4	Memory/RAM failure

4. If there is no failure with the system board, the LCD will cycle through the solid color screens described in the LCD-BIST section for 30 seconds and then power off.

## LCD Power rail test (L-BIST)

L-BIST is an enhancement to the single LED error code diagnostics and is automatically initiated during POST. L-BIST will check the LCD power rail. If there is no power being supplied to the LCD (that is if the L-BIST circuit fails), the battery status LED will flash either an error code [2,8] or an error code [2,7].

 **NOTE:** If L-BIST fails, LCD-BIST cannot function as no power will be supplied to the LCD.

### How to invoke L-BIST Test:

1. Press the power button to start the system.
2. If the system does not start up normally, look at the battery status LED:
  - If the battery status LED flashes an error code [2,7], the display cable may not be connected properly.
  - If the battery status LED flashes an error code [2,8], there is a failure on the LCD power rail of the system board, hence there is no power supplied to the LCD.
3. For cases, when a [2,7] error code is shown, check to see if the display cable is properly connected.
4. For cases when a [2,8] error code is shown, replace the system board.

## LCD Built-in Self Test (BIST)

Dell laptops have a built-in diagnostic tool that helps you determine if the screen abnormality you are experiencing is an inherent problem with the LCD (screen) of the Dell laptop or with the video card (GPU) and PC settings.

When you notice screen abnormalities like flickering, distortion, clarity issues, fuzzy or blurry image, horizontal or vertical lines, color fade etc., it is always a good practice to isolate the LCD (screen) by running the Built-In Self Test (BIST).

### How to invoke LCD BIST Test

1. Power off the Dell laptop.
2. Disconnect any peripherals that are connected to the laptop. Connect only the AC adapter (charger) to the laptop.
3. Ensure that the LCD (screen) is clean (no dust particles on the surface of the screen).
4. Press and hold **D** key and **Power on** the laptop to enter LCD built-in self test (BIST) mode. Continue to hold the D key, until the system boots up.
5. The screen will display solid colors and change colors on the entire screen to white, black, red, green, and blue twice.
6. Then it will display the colors white, black and red.
7. Carefully inspect the screen for abnormalities (any lines, fuzzy color or distortion on the screen).
8. At the end of the last solid color (red), the system will shut down.

 **NOTE:** Dell SupportAssist Pre-boot diagnostics upon launch, initiates an LCD BIST first, expecting a user intervention confirm functionality of the LCD.

# System-diagnostic lights

## Battery-status light

Indicates the power and battery-charge status.

**Solid white** — Power adapter is connected and the battery has more than 5 percent charge.

**Amber** — Computer is running on battery and the battery has less than 5 percent charge.

### Off

- Power adapter is connected, and the battery is fully charged.
- Computer is running on battery, and the battery has more than 5 percent charge.
- Computer is in sleep state, hibernation, or turned off.

The battery-status light blinks amber along with beep codes indicating failures.

For example, the battery-status light blinks amber two times followed by a pause, and then blinks white three times followed by a pause. This 2,3 pattern continues until the computer is turned off indicating no memory or RAM is detected.

The following table shows different power and battery-status light patterns and associated problems.

**Table 45. System diagnostic lights**

Blinking pattern		Problem description
Amber	White	
1	1	TPM detection failure
1	2	Unrecoverable SPI Flash Failure
1	3	Short in hinge cable tripped OCP1
1	4	Short in hinge cable tripped OCP2
1	5	EC unable to program i-Fuse
1	6	Generic catch-all for ungraceful EC code flow errors
1	7	Non-RPMC Flash on Boot Guard fused system
2	1	CPU failure
2	2	System board failure (included BIOS corruption or ROM error)
2	3	No memory/RAM detected
2	4	Memory/RAM failure
2	5	Invalid memory installed
2	6	System board/Chipset Error
2	7	LCD failure (SBIOS message)
2	8	LCD failure (EC detection of power rail failure)
3	1	CMOS battery failure
3	2	PCI or Video card/chip failure
3	3	BIOS recovery image not found
3	4	BIOS recovery image found but invalid
3	5	Power rail failure
3	6	Flash corruption detected by SBIOS.

**Table 45. System diagnostic lights (continued)**

Blinking pattern		Problem description
Amber	White	
3	7	Timeout waiting on ME to reply to HECI message.

**NOTE:** Blinking 3-3-3 LEDs on Lock LED (Caps-Lock or Num-Lock), Power button LED (without Fingerprint reader), and Diagnostic LED indicates failure to provide input during LCD panel test on Dell SupportAssist Pre-boot System Performance. Check diagnostics.

**Camera status light:** Indicates whether the camera is in use.

- Solid white — Camera is in use.
- Off — Camera is not in use.

**Caps Lock status light:** Indicates whether Caps Lock is enabled or disabled.

- Solid white — Caps Lock enabled.
- Off — Caps Lock disabled.

## Recovering the operating system

When your computer is unable to boot to the operating system even after repeated attempts, it automatically starts Dell SupportAssist OS Recovery.

Dell SupportAssist OS Recovery is a standalone tool that is preinstalled in all Dell computers installed with Windows operating system. It consists of tools to diagnose and troubleshoot issues that may occur before your computer boots to the operating system. It enables you to diagnose hardware issues, repair your computer, back up your files, or restore your computer to its factory state.

You can also download it from the Dell Support website to troubleshoot and fix your computer when it fails to boot into their primary operating system due to software or hardware failures.

For more information about the Dell SupportAssist OS Recovery, see *Dell SupportAssist OS Recovery User's Guide* at [www.dell.com/serviceabilitytools](http://www.dell.com/serviceabilitytools). Click **SupportAssist** and then, click **SupportAssist OS Recovery**.

## Real-Time Clock (RTC Reset)

The Real Time Clock (RTC) reset function allows you or the service technician to recover Dell systems from No POST/No Power/No Boot situations. The legacy jumper enabled RTC reset has been retired on these models.

Start the RTC reset with the system powered off and connected to AC power. Press and hold the power button for thirty to thirty five (30-35) seconds

. The system RTC Reset occurs after you release the power button.

## Backup media and recovery options

It is recommended to create a recovery drive to troubleshoot and fix problems that may occur with Windows. Dell proposes multiple options for recovering Windows operating system on your Dell PC. For more information, see [Dell Windows Backup Media and Recovery Options](#).

## Wi-Fi power cycle

### About this task

If your computer is unable to access the Internet due to Wi-Fi connectivity issues a Wi-Fi power cycle procedure may be performed. The following procedure provides the instructions on how to conduct a Wi-Fi power cycle:



 **NOTE:** Some ISPs (Internet Service Providers) provide a modem/router combo device.

### Steps

1. Turn off your computer.
2. Turn off the modem.
3. Turn off the wireless router.
4. Wait for 30 seconds.
5. Turn on the wireless router.
6. Turn on the modem.
7. Turn on your computer.

## Drain residual flea power (perform hard reset)

### About this task

Flea power is the residual static electricity that remains in the computer even after it has been powered off and the battery is removed.

For your safety, and to protect the sensitive electronic components in your computer, you are requested to drain residual flea power before removing or replacing any components in your computer.

Draining residual flea power, also known as performing a "hard reset", is also a common troubleshooting step if your computer does not power on or boot into the operating system.

### To drain residual flea power (perform a hard reset)

### Steps

1. Turn off your computer.
2. Disconnect the power adapter from your computer.
3. Remove the base cover.
4. Remove the battery.
5. Press and hold the power button for 20 seconds to drain the flea power.
6. Install the battery.
7. Install the base cover.
8. Connect the power adapter to your computer.
9. Turn on your computer.



 **NOTE:** For more information about performing a hard reset, search in the Knowledge Base Resource at [www.dell.com/support](http://www.dell.com/support).

# Getting help and contacting Dell

## Self-help resources

You can get information and help on Dell products and services using these self-help resources:

**Table 46. Self-help resources**

Self-help resources	Resource location
Information about Dell products and services	<a href="http://www.dell.com">www.dell.com</a>
My Dell app	
Tips	
Contact Support	In Windows search, type <code>Contact Support</code> , and press Enter.
Online help for operating system	<a href="http://www.dell.com/support/windows">www.dell.com/support/windows</a> <a href="http://www.dell.com/support/linux">www.dell.com/support/linux</a>
Access top solutions, diagnostics, drivers and downloads, and learn more about your computer through videos, manuals and documents.	Your Dell computer is uniquely identified by a Service Tag or Express Service Code. To view relevant support resources for your Dell computer, enter the Service Tag or Express Service Code at <a href="http://www.dell.com/support">www.dell.com/support</a> .  For more information on how to find the Service Tag for your computer, see <a href="#">Locate the Service Tag on your computer</a> .
Dell knowledge base articles for a variety of computer concerns	<ol style="list-style-type: none"> <li>1. Go to <a href="http://www.dell.com/support">www.dell.com/support</a>.</li> <li>2. On the menu bar at the top of the Support page, select <b>Support &gt; Knowledge Base</b>.</li> <li>3. In the Search field on the Knowledge Base page, type the keyword, topic, or model number, and then click or tap the search icon to view the related articles.</li> </ol>

## Contacting Dell

To contact Dell for sales, technical support, or customer service issues, see [www.dell.com/contactdell](http://www.dell.com/contactdell).

 **NOTE:** Availability varies by country/region and product, and some services may not be available in your country/region.

 **NOTE:** If you do not have an active Internet connection, you can find contact information about your purchase invoice, packing slip, bill, or Dell product catalog.